



HEALTHCORE  
VENTURES  
build.scale.expand.

# PRODUCT CATALOGUE

ENT SURGERY CATALOGUE

## ENT SURGERY INSTRUMENTS

<b>OTOLOGY INSTRUMENTS</b>	<b>1-23</b>
<b>MICRO EAR INSTRUMENTS</b>	<b>8-23</b>
<b>EAR ENDOSCOPIC INSTRUMENTS</b>	<b>13-15</b>
<b>BURR &amp; MICROMOTOR &amp; HANDPIECE</b>	<b>22-23</b>
<b>SCISSORS</b>	<b>24-27</b>
<b>RHINOLOGY/RHINOPLASTY</b>	<b>26-38</b>
<b>SINUSCOPY INSTRUMENTS</b>	<b>38-53</b>
<b>SKULL BASE INSTRUMENTS</b>	<b>54-61</b>
<b>TONSILECTOMY INSTRUMENTS</b>	<b>62-66</b>
<b>LARYNX/TRACHEOTOMY INSTRUMENTS</b>	<b>67-68</b>
<b>LARYNGO BRONCHO OESOPHAGOSCOPY</b>	<b>69-72</b>
<b>MICRO SCISSORS</b>	<b>75</b>
<b>MICRO &amp; GENERAL NEEDLE HOLDER</b>	<b>76-77</b>
<b>BIPOLAR INSTRUMENTS</b>	<b>78-80</b>
<b>GENERAL &amp; HOLLOWARE INSTRUMENTS</b>	<b>81-83</b>
<b>MICROSCOPE</b>	<b>84</b>
<b>GENERAL EQUIPMENT, HEAD LIGHT &amp; LIGHT SOURCE</b>	<b>85-86</b>
<b>CHAIR, ENT UNIT , TEMPORAL BONE WORK STATION</b>	<b>87-89</b>

# OTOLOGY INSTRUMENTS



**GRUBER**  
AURAL SPECULUM



**HARTMANN - BLACK**  
AURAL SPECULUM



**HARTMANN**  
AURAL SPECULUM



**HEATH**  
AURAL SPECULUM  
OVAL SHAPE



5MM  
7MM  
**HOLMGREN**  
SELF RETAINING AURAL SPECULUM



**ROSEN**  
AURAL SPECULUM  
SET OF 4



**SHEA**  
AURAL SPECULUM  
SET OF 4



**ROSEN**  
AURAL SLOTTED  
SPECULUM  
SET OF 4



**TUMARKIN TAPERED**  
SLOTTED AURAL  
SPECULUM  
SET OF 4



**SIEGLE PNEUMATIC**  
SPECULUM SET OF 3



SPECCULUM HOLDING ARM



**LEMPERT**  
ENDAURAL SPECULUM



**0°  
30°**  
Ear Canal Endoscope  
Autoclave able O.D 4MM



**HARTMANN**  
TUNING FORKS

128 HZ	1024 HZ
256 HZ	2048 HZ
512 HZ	4096 HZ



**ADSON FORCEPS**  
S.S

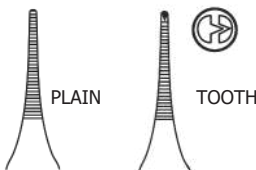

PLAIN

TOOTH

6"

6"

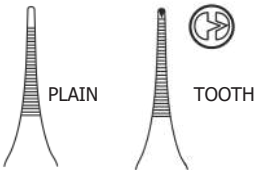

PLAIN

TOOTH

Fine 5"

Fine 5"

Micro Fine 5"  
Micro Fine 5"  
(0.3mm)

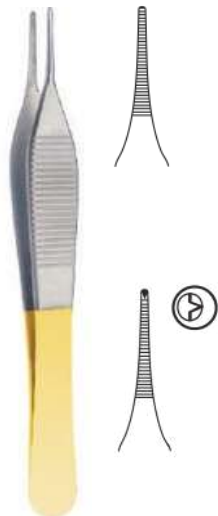

**ADSON FORCEPS**  
PLAIN- 5" FINE  
T.C



**OSSICLE**  
HOLDING CLAMP



**ADSON BROWN**  
FORCEPS 5"



T.C



**FAGGE AURAL FORCEPS PLAIN**

60MM 5½"  
80MM 6"  
100MM 7"

S.S.



**FAGGE AURAL FORCEPS PLAIN**

80MM 6"

T.C.



**FAGGE AURAL FORCEPS 1x2 TOOTH**

80MM 6"

S.S.



**WILDE AURAL FORCEPS**

55MM 5"  
75MM 6"  
100MM 7"

S.S.



**AURAL SYRINGE METAL WITH 2 PIPES CONICAL**

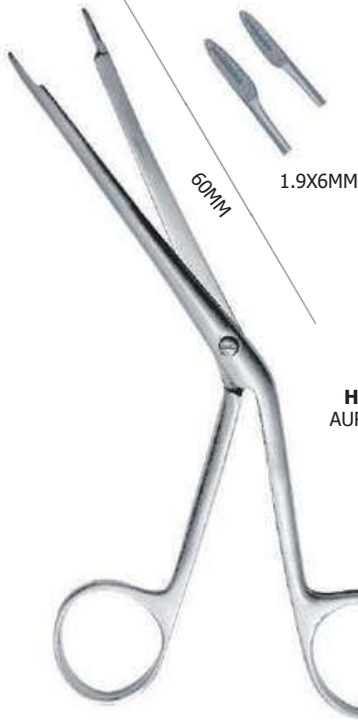

**HARTMANN AURAL FORCEPS**

S.S.

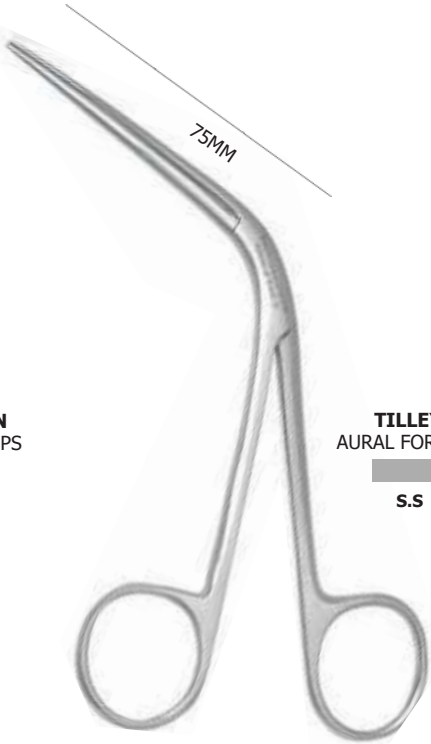

**TILLEY AURAL FORCEPS**

S.S.

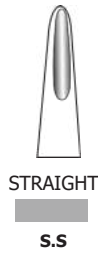

STRAIGHT

S.S.

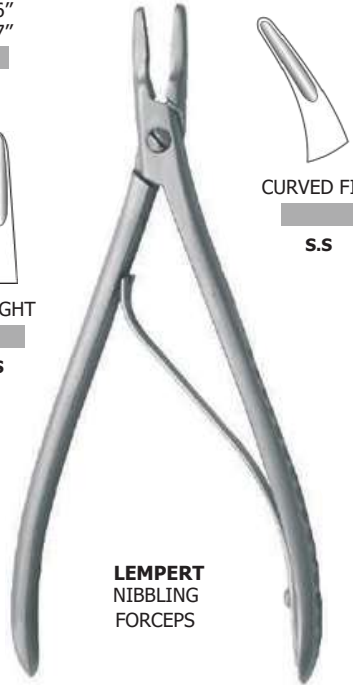

**LEMPERT NIBBLING FORCEPS**

CURVED FINE

S.S.

# Otology Instruments



SHARP

- 1.5MM
- 2.0MM
- 2.5MM
- 3.0MM

BLUNT

- 1.5MM
- 2.0MM
- 2.5MM
- 3.0MM

**RING CURETTE  
BUCK, 16CM**



1.5 MM  
BLUNT



2.5 MM  
BLUNT



1.5 MM



2.5 MM

**WAGNER HOOK  
DELICATE, 16CM**



2.5X4.5MM



3.5X5MM

**WIRE, 16.5CM  
WAX REMOVER**



**FOREIGN  
BODY REMOVING**



**FOREIGN BODY  
& HARD WAX REMOVING**



**FORMBY  
CERUMEN  
SCOOP & HOOK**



**JOBSON  
HORNE  
PROBES**



**16.5 CM  
CHILD**



**19 CM  
ADULT**



**HOVEL 16.5cm  
WAX LOOP**



**PLESTER SELF**  
RETAINING RETRACTOR  
2x2 PRONGS  
SEMI SHARP



**WULLSTEIN SELF**  
RETAINING RETRACTOR  
2x3 PRONGS  
SEMI SHARP  
BLUNT



**WULLSTEIN SELF**  
RETAINING RETRACTOR  
3x4 PRONGS  
SEMI SHARP  
BLUNT



**WULLSTEIN SELF**  
RETAINING RETRACTOR  
3x3 PRONGS  
SEMI SHARP



**PLESTER SELF**  
RETAINING RETRACTOR  
RIGHT SOLID BLADE



**PLESTER SELF**  
RETAINING RETRACTOR  
LEFT SOLID BLADE



**PLESTER JANSEN**  
RETRACTOR  
RIGHT SOLID BLADE



**PLESTER JANSEN**  
RETRACTOR  
LEFT SOLID BLADE



**JANSEN**  
RETRACTOR



**JULLSGURG** SELF  
RETAINING RETRACTOR



**CONE SELF**  
RETAINING ADJUSTABLE  
RETRACTOR 3X4  
16 CM  
20 CM



**TEMPORAL**  
BONE HOLDER



**HOUSES GRAFT**  
PRESS FORCEPS



**STRAIGHT**

- 1.0mm
- 1.5mm
- 2.0mm
- 2.5mm
- 3.0mm
- 4.0mm
- 5.0MM

**CURVED**

- 1.0mm
- 1.5mm
- 2.0mm
- 2.5mm
- 3.0mm
- 4.0mm
- 5.0MM

**LEMPERT**  
MASTOID CURETTE  
21CM



**CURVED**  
12MM

**STRAIGHT**  
12MM

**FARABEU**  
ELEVATOR



- 2mm
- 3mm
- 4mm
- 6mm
- 8mm
- 10mm

**JANSEN**  
CHISEL  
140mm



- 2mm
- 3mm
- 4mm
- 6mm
- 8mm
- 10mm

**JENKINS**  
GOUGE  
140mm

# Suction Cannulas

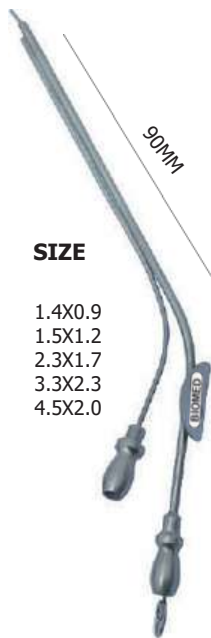

**SIZE**

- 1.4X0.9
- 1.5X1.2
- 2.3X1.7
- 3.3X2.3
- 4.5X2.0

**SUCTION IRRIGATION TUBE WITH CHANNEL**



**SIZE**

- 2 MM
- 2.7 MM
- 3.3 MM

**FRAZIER SUCTION TUBES WITH LARGE KEY HOLE, FOR SUCTION CONTROL**

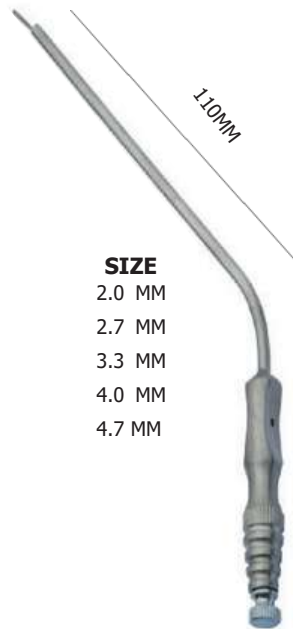

**SIZE**

- 2.0 MM
- 2.7 MM
- 3.3 MM
- 4.0 MM
- 4.7 MM

**LEMPERT MASTOID SUCTION TUBES**



**SIZE**

- 2.7 MM
- 3.3 MM
- 4.3 MM
- 5.0 MM

**FRAZIER SUCTION TUBES, BALL END**



**SIZE**

- 3 FR
- 5 FR
- 7 FR
- 9 FR
- 12 FR

**BARRON SUCTION TUBE**



**SIZE**

- 2.3 MM
- 3.3 MM
- 4.3 MM

**EUSTACHIAN CATHETER**



**ZOLLNER SUCTION TUBES WITH 3 CANULAS**



**SIZE**

- 12
- 14
- 16
- 18
- 20
- 21
- 22
- 23
- 24

**VERHOEVEN SUCTION TUBES**



**VERHOEVEN SUCTION TUBES ADAPTOR**

**SUCTION TUBES CONNECTOR**

### INSTRUMENTS FOR TRAINING

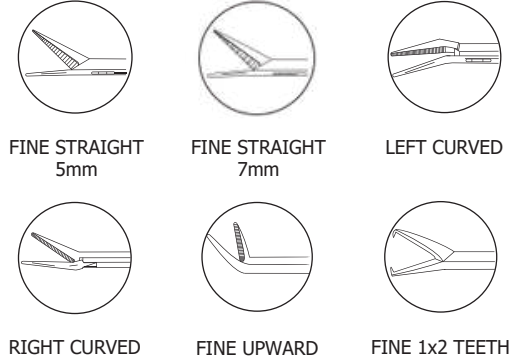

FINE STRAIGHT 5mm    FINE STRAIGHT 7mm    LEFT CURVED  
 RIGHT CURVED    FINE UPWARD    FINE 1x2 TEETH



**MICRO AURAL CROCODILE FORCEPS SERRATED (FOR TRAINING)**

### INSTRUMENTS FOR TRAINING

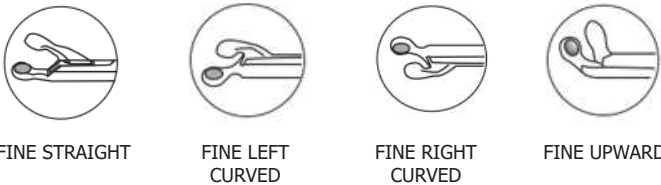

FINE STRAIGHT    FINE LEFT CURVED    FINE RIGHT CURVED    FINE UPWARD



**MICRO AURAL CUP FORCEPS (FOR TRAINING)**

### INSTRUMENTS FOR TRAINING

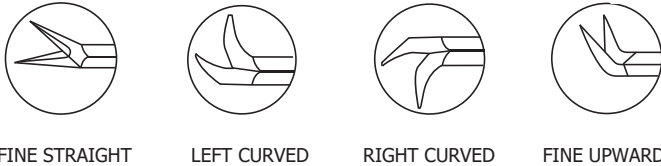

FINE STRAIGHT    LEFT CURVED    RIGHT CURVED    FINE UPWARD



**MICRO AURAL SCISSORS (FOR TRAINING)**

### INSTRUMENTS FOR TRAINING

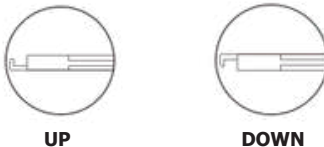

UP    DOWN



**HOUSE DIETER MALLEUS NIPPERS (FOR TRAINING)**

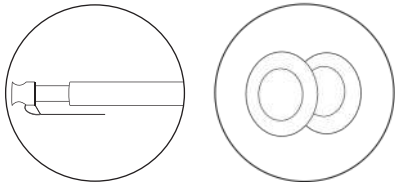

100MM



**GROMMET TUBE  
INSERTER**

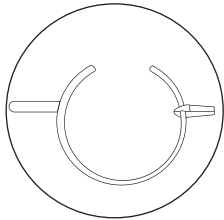

**TEFLON PISTON  
HOLDING FORCEPS**

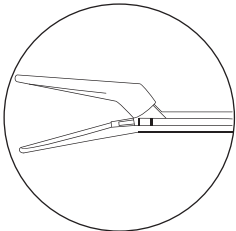

**MC GEE  
WIRE CLOSING FORCEPS**

# Othology Instruments

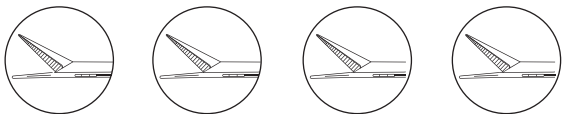

STRAIGHT (O.P.D) USE BIG SIZE 1.8 x8mm  
 STRAIGHT FINE 0.8 x3mm  
 STRAIGHT FINE 0.8 x5mm  
 STRAIGHT FINE 0.8 x7mm



LEFT CURVED 0.8 x5mm  
 RIGHT CURVED 0.8 x5mm  
 FINE UPWARD 0.8 x5mm  
 FINE 1x2 TEETH 0.8 x5mm  
 FINE DOWN 0.8 x5mm



STRAIGHT 1.5X6.5MM



Up 45 1.5X6.5MM



STRAIGHT CUP 0.8X1.3



STRAIGHT CUP 2.5MM



FINE DOWN 0.8X1.3MM



FINE UPWARD 0.8X1.3MM



FINE LEFT CURVED 0.8X1.3MM



FINE RIGHT CURVED 0.8 X1.3MM

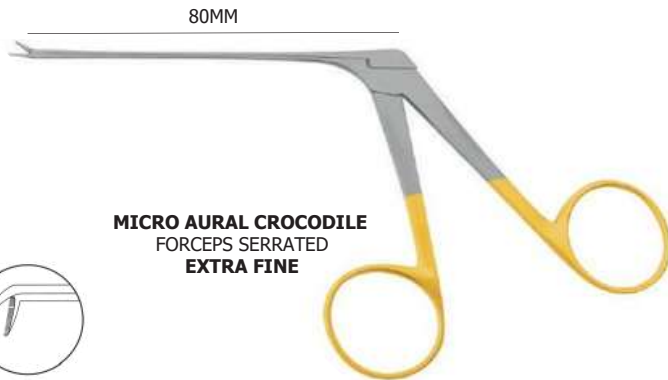

MICRO AURAL CROCODILE FORCEPS SERRATED EXTRA FINE



MICRO AURAL TILLEY HANDLE FORCEPS



MICRO AURAL CUP FORCEPS EXTRA FINE

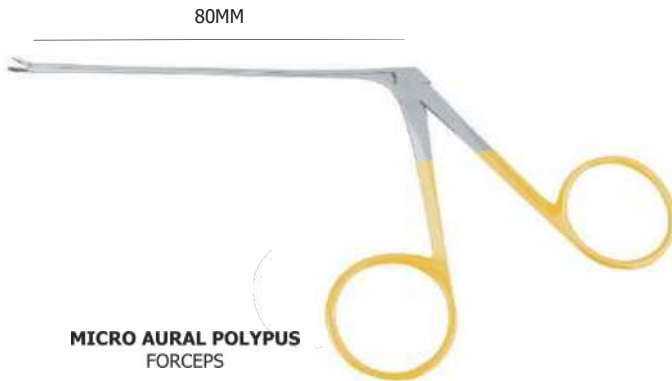

MICRO AURAL POLYPUS FORCEPS

# Othology Instruments



FINE STRAIGHT  
4MM



FINE STRAIGHT  
8MM



LEFT CURVED  
4MM



RIGHT CURVED  
4MM



FINE UPWARD  
4MM



STRAIGHT 4MM  
SIDE CUTTING  
BELLUCCI MICRO SCISSOR

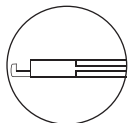

UP

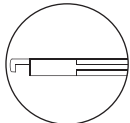

DOWN



STRAIGHT  
0.6X6MM

  
TITANIUM



STRAIGHT 2MM

  
TITANIUM

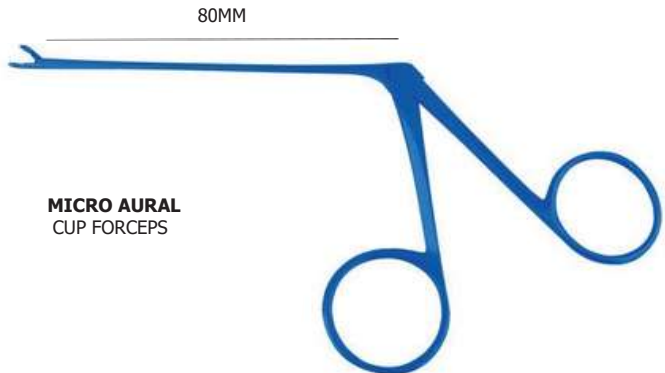
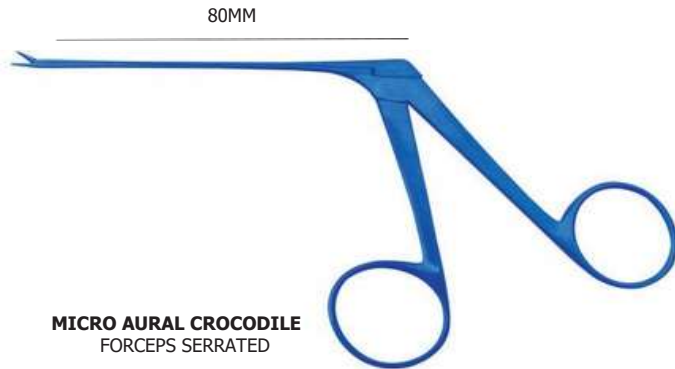
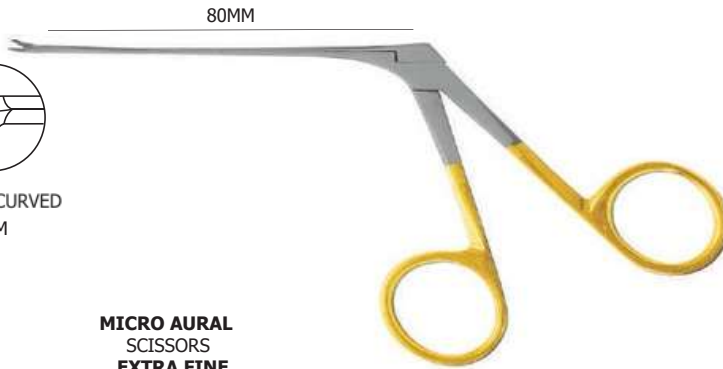

# Othology Instruments

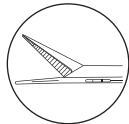

**STRAIGHT FINE**  
0.8 x3mm

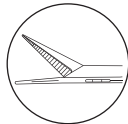

**STRAIGHT FINE**  
0.8 x5mm



**FINE STRAIGHT**  
0.8X1.3

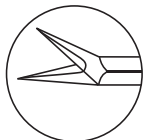

**FINE STRAIGHT**  
4MM

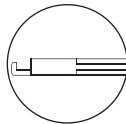

**UP**

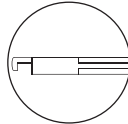

**DOWN**



**MICRO AURAL CROCODILE**  
**FORCEPS SERRATED**  
**EXTRA FINE**  
BLACK COATED



**MICRO AURAL**  
**CUP FORCEPS**  
**EXTRA FINE**  
BLACK COATED



**MICRO AURAL**  
**SCISSORS**  
**EXTRA FINE**  
BLACK COATED



**HOUSE DIETER**  
**MALLEUS NIPPERS**  
**EXTRA FINE**  
BLACK COATED



**Suction dissector with rotatable adapter  
single curved, right**



**Suction dissector with rotatable adapter  
single curved, Left**



**Suction dissector with rotatable adapter  
single curved, right curved fine**



**Suction dissector with rotatable adapter  
single curved, Left curved fine**



**Suction dissector with rotatable adapter  
double curved right**



**Suction dissector with rotatable adapter  
double curved Left**



**Suction dissector with rotatable adapter  
curved, forward right**



**Suction dissector with rotatable adapter  
curved, forward Left**



**SUCTION TUBE, CURVED**  
LUER-LOCK , WORKING LENGTH 10CM

**SIZE 45° 90°**  
18 G  
20 G  
21 G



**SUCTION MICRO HOOK with rotatable adapter  
45° 1.0MM**



**SICKLE KNIFE with rotatable adapter  
SUCTION 3mm**



**CIRCULAR KNIFE with rotatable adapter  
45° SUCTION 2.5MM**



**Suction knife, oval with rotatable adapter  
2.5 mm**



**PLESTER  
FIRST INCISION KNIFE SUCTION with rotatable adapter  
2.5MM**



**MICRO CURETTE with rotatable adapter  
SUCTION**



**Suction dissector, blunt with rotatable adapter  
curved right**



**Suction dissector, blunt with rotatable adapter  
curved Left**



**Suction Elevator with rotatable adapter  
SUCTION**

# Ear Endoscopic Instruments



EAR HOOK , CURVED TO RIGHT



EAR HOOK , CURVED TO LEFT



EAR HOOK , CURVED TO BACKWARDS



EAR DISSECTOR , CURVED TO RIGHT



EAR DISSECTOR , CURVED LRFT



CURETTE,SPOON - SHAPE , 1MM



EAR DISSECTOR , CURVED TO BACKWARD

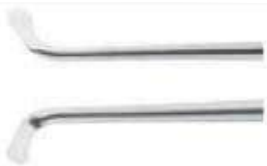

DISSECTOR , DOUBLE - ENDED, DISTAL TIPS  
SINGLE CURVED TO RIGHT OR TO LEFT

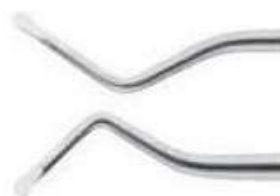

DISSECTOR , DOUBLE - ENDED, DISTAL TIPS  
DOUBLE CURVED TO RIGHT OR TO LEFT



DISSECTOR , DOUBLE - ENDED, DISTAL TIPS  
ANGLED 90 DEGREE TO RIGHT OR TO LEFT C

# Ear Endoscopic Instruments



19,0 cm – 7½"

### MICRO SCISSORS



### MICRO FORCEPS



### MICRO FORCEPS

### MICRO FORCEPS



### MICRO CUP FORCEPS

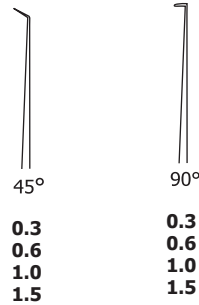
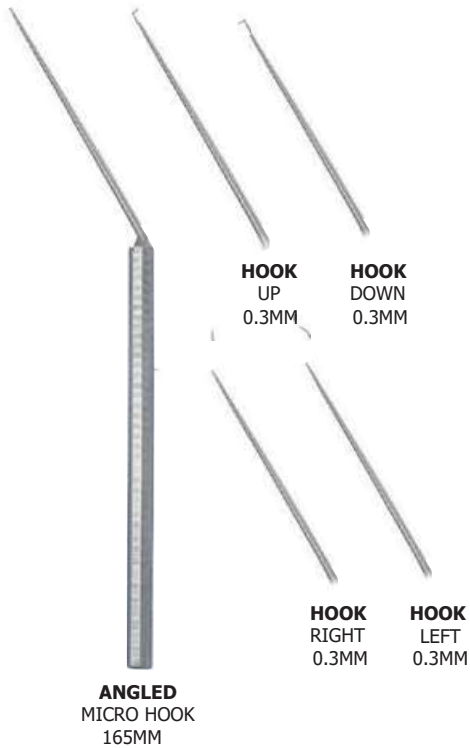

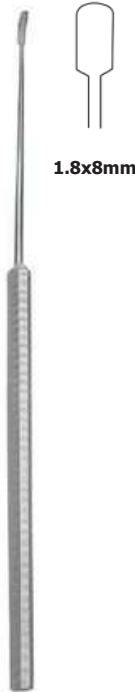

**BEALES**  
RASPATORY  
165MM

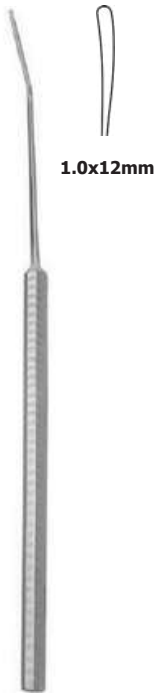

**ROSEN**  
ELEVATOR  
165MM



**ANGLED**  
ELEVATOR  
165MM



**FISCH**  
RASPATORY RIGHT  
165MM



**FISCH**  
RASPATORY LEFT  
165MM



**ROSEN**  
CURETTE  
CURVED 165MM



**ROSEN**  
CURETTE  
165MM



**BALL**  
PROBE  
165MM



**HOUSE**  
CURETTE  
DOUBLE ENDED  
170MM



**HOUSE**  
CURETTE ANGLED  
DOUBLE ENDED  
170MM

# Otology Instruments

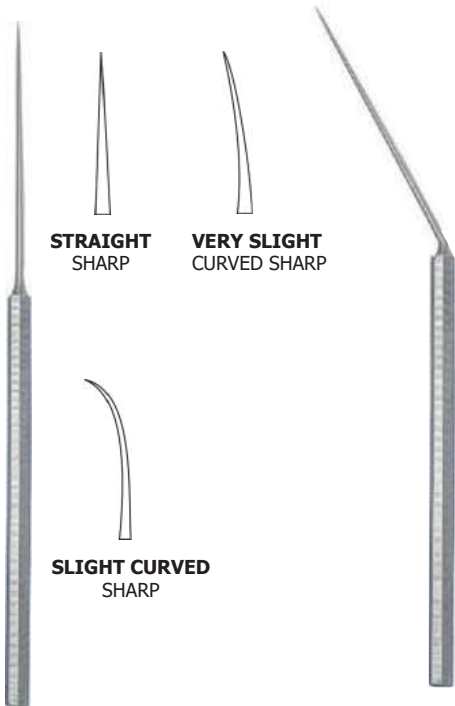

**STRAIGHT SHARP**  
**VERY SLIGHT CURVED SHARP**

**SLIGHT CURVED SHARP**

**WULLSTEIN PICK**  
NEEDLE 165MM



**WULLSTEIN PICK LARKIN PENETRATION**  
NEEDLE ANGLED 165MM

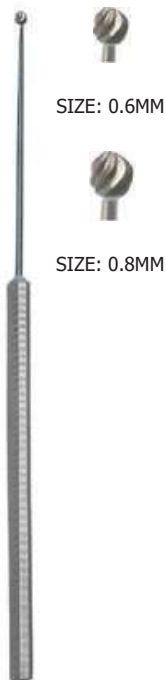

SIZE: 0.6MM  
SIZE: 0.8MM



3.5MM  
4.0MM  
4.5MM

**HOUSE MEASURING**  
RODS 165MM



3.5MM  
4.0MM  
4.5MM

**SHEA PISTON**  
DEPTH GAUGE 165MM

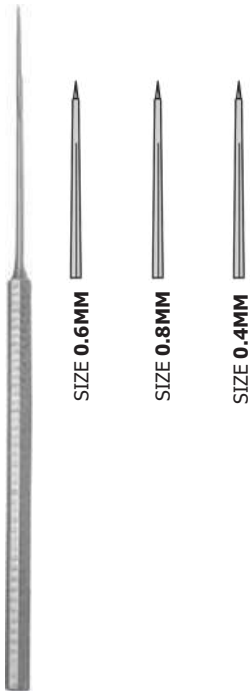

SIZE 0.6MM  
SIZE 0.8MM  
SIZE 0.4MM

**DR. KIRTANE**  
PERFORATOR WITH GUARD  
165MM



**MEASURING JIG**



5X2MM

**MYRINGOTOMY**  
KNIFE



5X2MM

**TYMPANUM**  
EAR KNIFE



**LAKE SEEKER**  
HOOK/PROBE

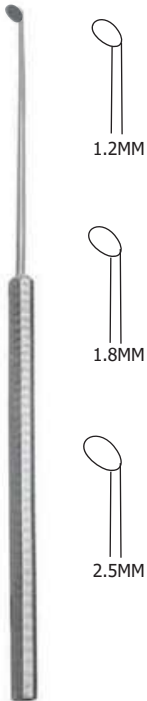

**CIRCULAR CUTTING KNIFE 45°,165MM**



**CIRCULAR CUTTING KNIFE WITH HOLDE,165MM**



**CIRCULAR CUTTING KNIFE 45°,165MM**

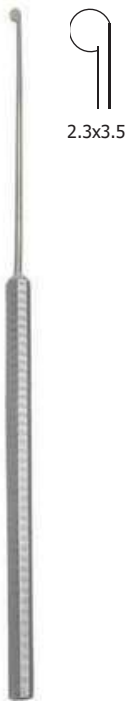

**PLESTER FLAG CUTTING KNIFE 45°,165MM**



**DR.DHINGRA SICKLE KNIFE WITH SAW,165MM**

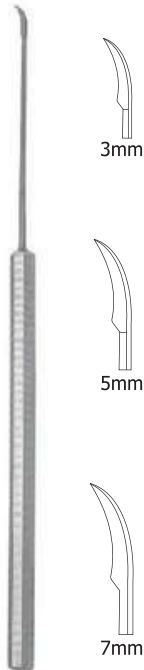

**SICKLE KNIFE 165MM**



**SICKLE KNIFE ANGLED UP 165MM**



**SICKLE KNIFE ANGLED DOWN 165MM**



**MICRO SICKLE CIRCULAR KNIFE**

# Otology Instruments



**MYRINGOTOMY KNIFE**  
BLACK COATED



**WULLSTEIN PICK NEEDLE ANGLED**  
BLACK COATED



**STRAIGHT SHARP**



**VERY SLIGHT CURVED SHARP**



**MICRO HOOK**

BLACK COATED



**CIRCULAR CUTTING KNIFE 60°**  
BLACK COATED



**CIRCULAR KNIFE WITH HOLE**  
BLACK COATED



**SICKLE KNIFE**  
BLACK COATED

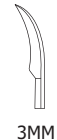

**PLESTER FIRIST INCISION KNIFE**  
BLACK COATED



**BEALES RASPATORY**  
BLACK COATED



# Otology Instruments



TITANIUM

**PLESTER FOOT  
PLATE HOOK  
(CROCIA)**

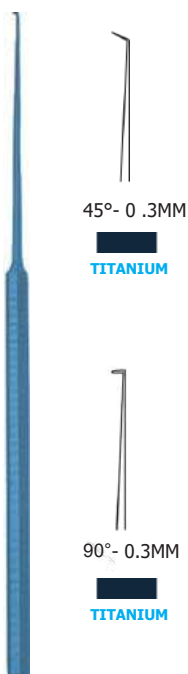

45° - 0.3MM

TITANIUM

**MICRO PICK**



HOOK  
UP 0.3MM

TITANIUM

HOOK  
DOWN 0.3MM

TITANIUM

**MICRO HOOK  
ANGLED 0.6MM**



5X2MM

TITANIUM

**MYRINGOTOMY  
KNIFE**



90° - 0.3MM

TITANIUM



HOOK  
RIGHT  
0.3MM

TITANIUM

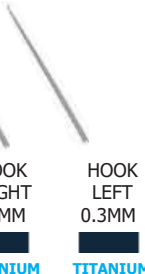

HOOK  
LEFT  
0.3MM

TITANIUM

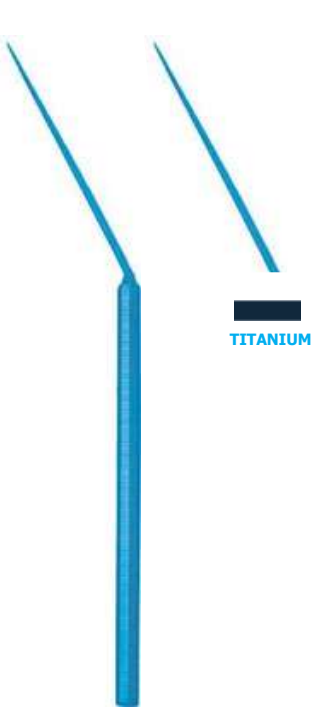

TITANIUM

**ANGLED WULLSTEIN  
NEEDLE**

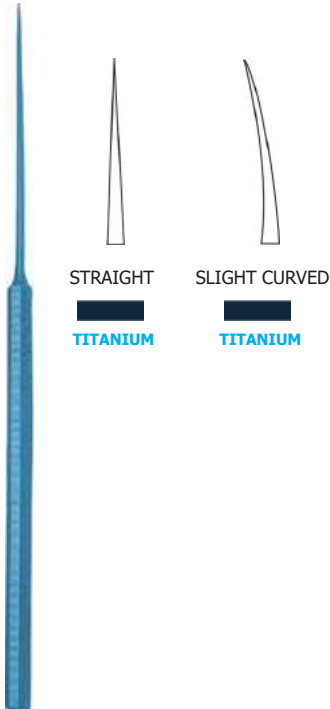

STRAIGHT

TITANIUM

SLIGHT CURVED

TITANIUM

**WULLSTEIN  
NEEDLE**



1.8x8mm

TITANIUM

**ROSEN  
ELEVATOR**

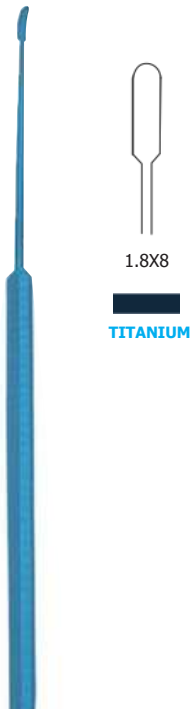

1.8X8

TITANIUM

**BEALES  
RASPATORY**

# Otology Instruments

## TITANIUM RANGE



**ROSEN**  
CURETTE

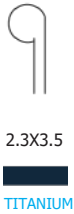

**PLESTER**  
FIRST INCISION KNIFE



**CIRCULAR**  
KNIFE WITH HOLE



**CIRCULAR CUTTING**  
KNIFE CURVED



**CIRCULAR CUTTING**  
KNIFE 60°

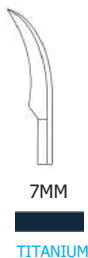

**SICKLE**  
KNIFE



**PERFORATOR** WITH  
GUARD 165MM



**BALL**  
PROBE



### STEEL CUTTING BURR (STAINLESS STEEL)



S.S



### CUTTING BURR (TUNGSTEN CARBIDE)



T.C



### DIAMOND PASTE BURR



DIAMOND

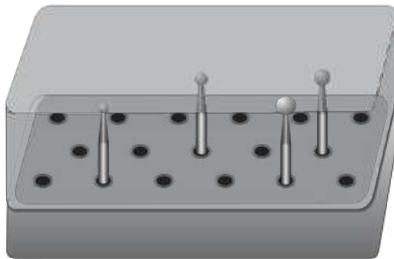
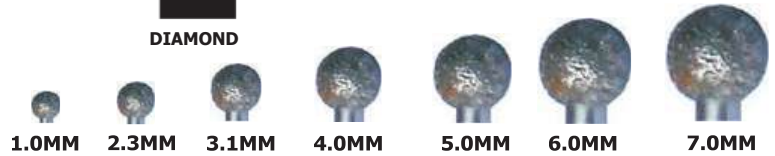

BURR STAND BLOCK

### CUTTING BURR OVAL SHAPE (STAINLESS STEEL)



S.S



# Micromotor & Handpiece



MICRO HANDPIECE WITH 35,000 RPM



MICRO STRAIGHT HANDPIECE WITH 40,000 RPM



MICRO SURGICAL STRAIGHT HANDPIECE WITH 40,000 RPM



MICRO SURGICAL ANGULAR HANDPIECE WITH 50,000 RPM TO 80,000 RPM



HANDPIECE SPRAY



High Performance Autoclave Titanium Brushless Micro Motor with Precise Torque control for Implant & Micro Surgery with Digital Display



SURGICAL MICRO DRILL  
Heavy Duty Micro Motors for forward & reverse cutting 40,000 rpm



Heavy Duty Micro Motors for forward & reverse cutting 40,000 rpm

# Scissors



**KNAPP SCISSORS**  
CURVED

4 1/2"



S.S

**KNAPP SCISSORS**  
STRAIGHT

4 1/2"



S.S



**KNAPP SCISSORS**  
CURVED

4 1/2"

5 1/2"



T.C

**KNAPP SCISSORS**  
STRAIGHT

4 1/2"

5 1/2"



T.C



**KNAPP SCISSORS**  
CURVED

4 1/2"

5 1/2"



S.C

**KNAPP SCISSORS**  
STRAIGHT

4 1/2"

5 1/2"

S.C



**IRIS SCISSORS**  
CURVED

3 1/2"

4"

5"



S.S

**IRIS SCISSORS**  
STRAIGHT

3 1/2"

4"

5"



S.S



**IRIS SCISSORS**  
CURVED

3 1/2"

4"

5"



T.C

**IRIS SCISSORS**  
STRAIGHT

3 1/2"

4"

5"



T.C



**IRIS SCISSORS**  
CURVED

4"

5"

S.C

**IRIS SCISSORS**  
STRAIGHT

4"

5"

S.C

# Scissors



**STEVENS SCISSORS**  
CURVED  
4½"  
S.S



**STEVENS SCISSORS**  
CURVED  
4½"  
5½"  
T.C

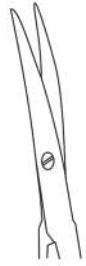

**STEVENS SCISSORS**  
CURVED  
4½"  
5½"  
S.C

**STEVENS SCISSORS**  
STRAIGHT  
4½"  
S.S

**STEVENS SCISSORS**  
STRAIGHT  
4½"  
5½"  
T.C

**STEVENS SCISSORS**  
STRAIGHT  
4½"  
5½"  
S.C



**GREEN BERG SCISSORS**  
CURVED  
5½"  
S.S



**GREEN BERG SCISSORS**  
CURVED  
5½"  
6½"  
T.C



**GREEN BERG SCISSORS**  
CURVED  
5½"  
6½"  
S.C

**GREEN BERG SCISSORS**  
STRAIGHT  
5½"  
S.S

**GREEN BERG SCISSORS**  
STRAIGHT  
5½"  
6½"  
T.C

**GREEN BERG SCISSORS**  
STRAIGHT  
5½"  
6½"  
S.C

# Scissors



**FOMAN UPPER**  
LATERAL SCISSORS



**O'BRIEN STICH**  
REMOVING ANGLED  
SCISSORS

T.C



**WALTER SCISSORS**  
CURVED ANGLED 10CM

S.S T.C

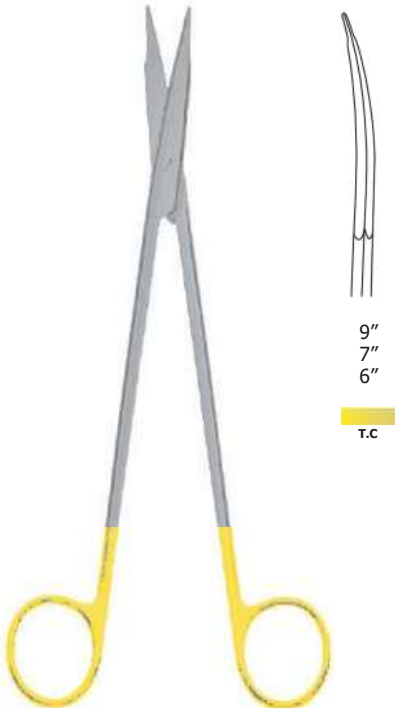

**JAMISON METZENBAUM**  
SCISSORS NARROW  
TIP BLUNT CURVED

9"  
7"  
6"  
T.C



**JOSEPH SCISSOR**  
15CM/6"

STRAIGHT CURVED  
S.S  
T.C  
S.C



**KELLY SCISSORS**  
Straight 16cm-6 1/4"

S.S  
T.C



**HEYMANN TURBINECTOMY**  
SCISSORS, working length-95mm



**HEYMANN TURBINECTOMY**  
SCISSORS working length-95mm  
**TUNGSTEN CARBIDE**

T.C



**FOMAN ANGULAR**  
SCISSORS



**FOMAN ANGULAR**  
SCISSORS  
**TUNGSTEN CARBIDE**

T.C



**SEPTUM CUTTING**  
PUNCH, -190mm



**SEPTUM CUTTING**  
SCISSORS ,180mm



**SEPTUM MORCELIZER**  
220 mm



**COTTLE SEPTAL**  
SCISSORS  
SPRING ANGULAR BOWS

# Rhinology/Rhynoplasty





**FLEXIBLE ARM RETRACTOR**



**HOLDING ROD**



**NASAL RETRACTOR BY AUFRICHT**  
WITH BOREHOLE FOR FIXATION TO FLEXIBLE ARM  
ATTACHMENT 1



**NASAL RETRACTOR BY AUFRICHT WITH**  
TWO PRONGS WITH BOREHOLE FOR FIXATION  
TO FLEXIBLE ARM



**BALL & SOCKET JOINT**



**COUPLING HEAD**  
TO TAKE 1 – 5 FLEXIBLE



**SUPPORT for 2202 & 2203**



**SINUS NASAL SPECULUM by KILLIAN**  
OVERALL LENGTH 140MM with BOREHOLE for FIXATION to  
FLEXIBLE ARM ATTACHMENT



RIGHT



LEFT

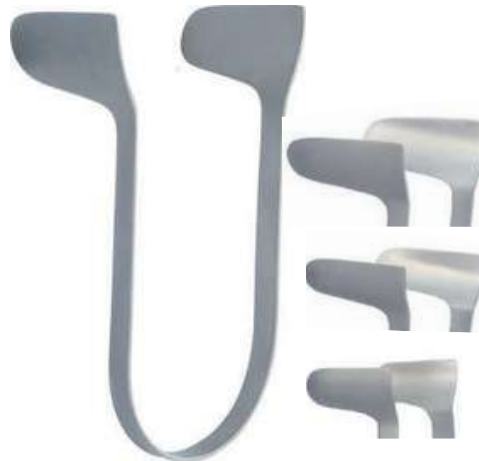

**THUDICHUM**  
NASAL SPECULUM SET OF 3



**COTTLE COLUMELLA**  
FORCEPS  
LENGTH-105MM

# Rhinology/Rhynoplasty



**COTTLE**  
RETRACTOR  
BLUNT



**COTTLE**  
RETRACTOR  
SHARP



**JOSEPH**  
RETRACTOR  
FINE SHARP



**GILLIES**  
SKIN HOOK



**TITANIUM**



**ALAR**  
RETRACTOR



**COTTLE UPPER**  
TEFLON COATED RETRACTOR



**COTTLE UPPER**  
RETRACTOR



**KILNER**  
RETRACTOR



SHARP



BLUNT



**JOSEPH NASAL SAW**  
LEFT



RIGHT

# Rhinology/Rhynoplasty



**SMR**  
ELEVATOR BROAD  
4.5MM



**SMR**  
ELEVATOR FINE



**FREER**  
ELEVATOR



**HOWARTH**  
ELEVATOR



**Dr. V.P. SOOD**  
ELEVATOR



**MASING**  
ELEVATOR WITH  
GRADUATED



**SLIGHTLY  
CURVED SIMI ROUND**  
4X6MM



**MASING**  
ELEVATOR WITH  
GRADUATED



**SLIGHTLY  
CURVED FINE**  
3X5MM



**JOSEPH NASAL**  
ELEVATOR



**DISSECTOR**  
WITH SUCCER



**ROSS RASPATORY**  
RIGHT

RIGHT



LEFT



**TILLEY LICHTWITZ**  
ANTRAL TROCAR &  
CANNULA

- SIZE**
- 1 MM
  - 2 MM
  - 3 MM

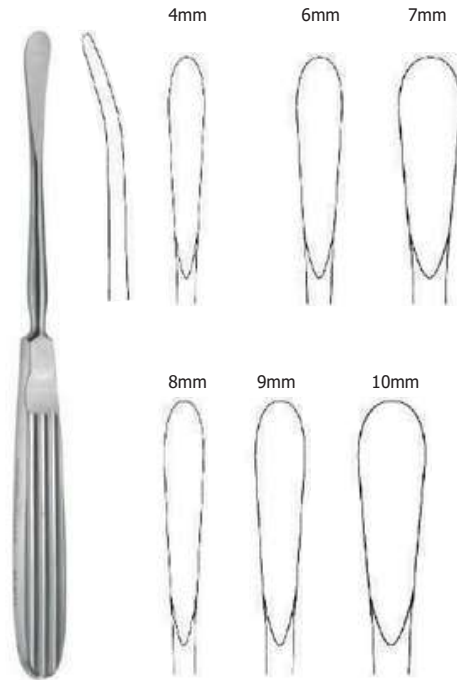

**COTTE**  
**RASPATORIEN**  
ROUND 18cm

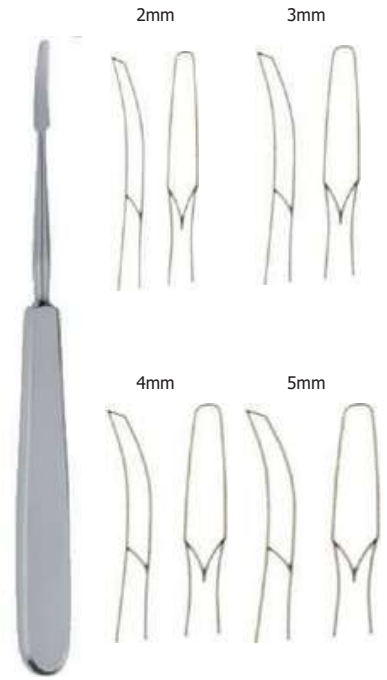

**JOSEPH**  
**RASPATORIEN**  
18cm



**LUC NASAL TURBINATE**  
FORCEPS OVAL SHAPE



**AUFRIGHT**  
**NASAL RETRACTOR**  
WITH FIBEROPTIC LIGHT



**AUFRIGHT**  
**NASAL RETRACTOR**



**V.P. SOOD AUFRIGHT**  
NASAL RETRACTOR

# Rhinology/Rhynoplasty



16CM FINE  
20CM

**HARTMANN**  
NASAL DRESSING FORCEPS



**WATSON WILLIAMS**  
NASAL POLYPUS FORCEPS



SIZE  
5 MM  
6 MM  
7 MM

**BIOPSY**  
PUNCH FORCEPS



**WALSHAM**  
SEPTUM STRAIGHTENING FORCEPS

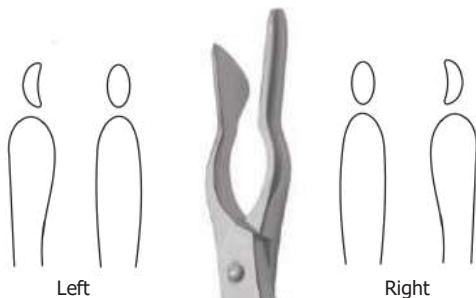

**WALSHAM**  
SEPTUM FORCEPS



**ASH SEPTUM**  
FORCEPS

# Rhinology/Rhynoplasty



**SIZE**

- 4mm
- 6mm
- 8mm
- 10mm
- 12mm
- 15mm

**OSTEOTOME**  
MOON TYPE



**SIZE**

- 4mm
- 5mm

**TILLEY SEPTUM**  
GOUGE V-SHAPE



**SIZE**

- 4mm
- 5mm

**KILLIAN**  
NASAL GOUGE



**SIZE**

- 4mm
- 6mm
- 8mm
- 10mm
- 2mm

**ROZNER NASAL**  
OSTEOTOME



**STRAIGHT**

- 2mm
- 3mm
- 4mm
- 6mm
- 8mm
- 10mm

**GILLIES**  
CHISEL



**SIZE**

- 2mm
- 3mm
- 4mm
- 6mm
- 8mm
- 10mm

**GILLIES**  
GOUGE



**STRAIGHT**

- 2mm
- 3mm
- 4mm
- 6mm
- 8mm
- 10mm

**GILLIES**  
OSTEOTOME

**CURVED**

- 2mm
- 3mm
- 4mm
- 6mm
- 8mm
- 10mm



**SIZE**

- 2mm
- 3mm
- 4mm
- 5mm
- 6mm

**MEASURING**  
OSTEOTOME



**SILVER CHISEL**  
LEFT



**SILVER CHISEL**  
RIGHT



**SILVER CHISEL**  
STRAIGHT



**BALLENGER SWIVEL**  
KNIFE BAYONET



**MALLET**  
WITH PLASTIC HEAD



**MALLET**

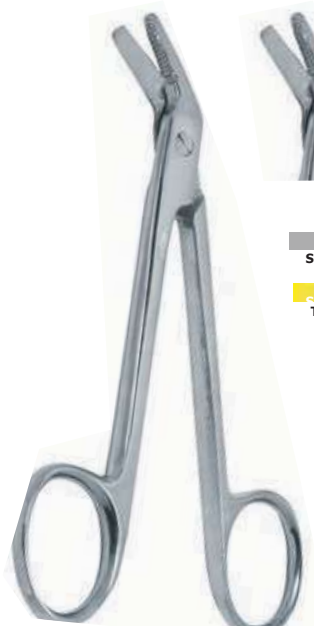

**WIRE CUTTING**  
SCISSORS



**WIRE CUTTER FINE**  
TUNGSTEN CARBIDE

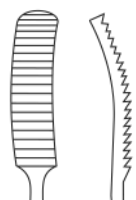

**MALTZ RASP**



**JOSEPH NASAL RASP FINE**



**AUFRIGHT NASAL RASP**



**JOSEPH NASAL RASP**



Fig. 1



Fig. 3



Fig. 5

**DOUBLE ENDED RASP**



**S.S**



Fig. 6



Fig. 8



Fig. 10



**FINE CUTTING**

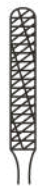

**SHARP CUTTING**

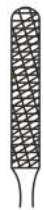

**MEDIUM CUTTING**



Fig. 1



Fig. 2



Fig. 3

**DOUBLE ENDED RASP**



**T.C**



Fig. 5



Fig. 6



Fig. 7

**COTTLE RASP**



**T.C**

# Rhinology/Rhynoplasty



**CALIPER**  
STRAIGHT

■  
S.S  
■  
TITANIUM



**CALIPER**  
CURVED



**SILVER SKIN**  
GRAFTING KNIFE  
FOR SAVING BLADES USE



**HUMBY SKIN**  
GRAFTING  
HANDLE



**WATSON SKIN**  
GRAFTING  
HANDLE

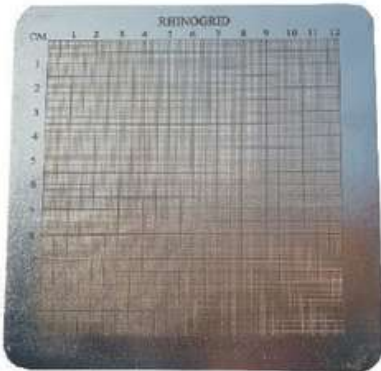

**SHEEN**  
Rhinogrid  
P-12767

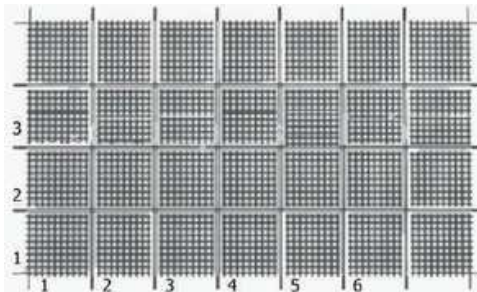

**SHEEN**  
Aluminium grid



**CATLAGE**  
CRUSHER



**AIACH FORCEPS**  
16cm 5mm Tip

## ABBEY SUB MUCOSAL RESECTION



SIZE  
2.5 MM  
3 MM  
4 MM

**V. EICKEN MONOPOLAR ANTRUM CANNULA**  
15CM, LONG CURVED



SIZE  
2.5 MM  
3.5 MM  
4.5 MM

**MONOPOLAR SUCTION TUBE**



SUCTION TUBE



NEEDLE



PROBE



KNIFE



SIZE  
3.5MM

**ANTRUM MONOPOLAR SUCTION TUBE** 3.5MM



SIZE  
2 MM  
2.7 MM  
3.3 MM

**FRAZIER SUCTION TUBES WITH LARGE KEY HOLE, FOR SUCTION CONTROL**



SIZE  
2.0 MM  
2.7 MM  
3.3 MM  
4.0 MM  
4.7 MM

**LEMPERT MASTOID SUCTION TUBES**

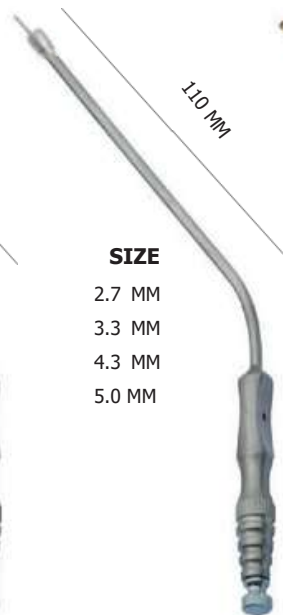

SIZE  
2.7 MM  
3.3 MM  
4.3 MM  
5.0 MM

**FRAZIER SUCTION TUBES, BALL END**



CABLE



**ANTRAL WASH RUBBER SYRINGE**

## SINUSCOPE (TELESCOPES)

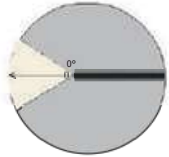
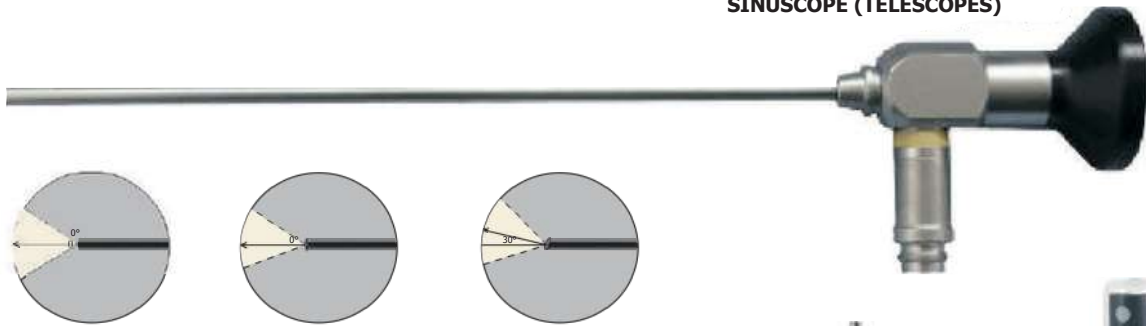

**STRAIGHT FORWARD**  
WIDE ANGLE 0° 2.7MM

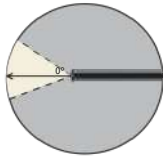

**STRAIGHT FORWARD**  
WIDE ANGLE 0° 4MM

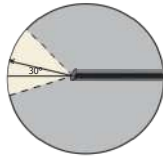

**FORWARD OBLIQUE**  
WIDE ANGLE 30° 2.7MM



**FORWARD OBLIQUE**  
WIDE ANGLE 30° 4MM

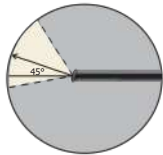

**FORWARD OBLIQUE**  
WIDE ANGLE 45° 4MM

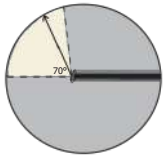

**LATERAL WIDE ANGLE**  
70° 4MM



**SINUSCOPE HANDLE**  
ROUND 11CM



**LENS CLEANER SPRAY**



**LED PORTABLE LIGHT SOURCE**  
RECHARGEABLE



**BALL & SOCKET JOINT**  
(table mount)



**ENDOSCOPE HOLDER**  
WITHOUT TABLE MOUNT





SIZE  
2.5 MM  
3 MM  
4 MM

**V. EICKEN  
ANTRUM CANNULA**  
15CM, SHORT CURVED



SIZE  
2.5 MM  
3 MM  
4 MM

**EICKEN ANTRUM  
CANNULA**  
LONG CURVED



SIZE  
1.4X0.9  
1.5X1.2  
2.3X1.7  
3.3X2.3  
4.5X2.0

**SUCTION  
IRRIGATION TUBE**  
WITH CHANNEL



**MALLEABLE  
SUCTION**



**MALLEABLE  
PROBE**



**ANTRUM  
BALL PROBE**  
DOUBLE ENDED



**FRONTAL  
SINUS SEEKER**



**MAXILLARY  
SINUS SEEKER**



**FRONTAL  
SINUS SEEKER**  
STRONG CURVED

# Sinuscopy Instruments

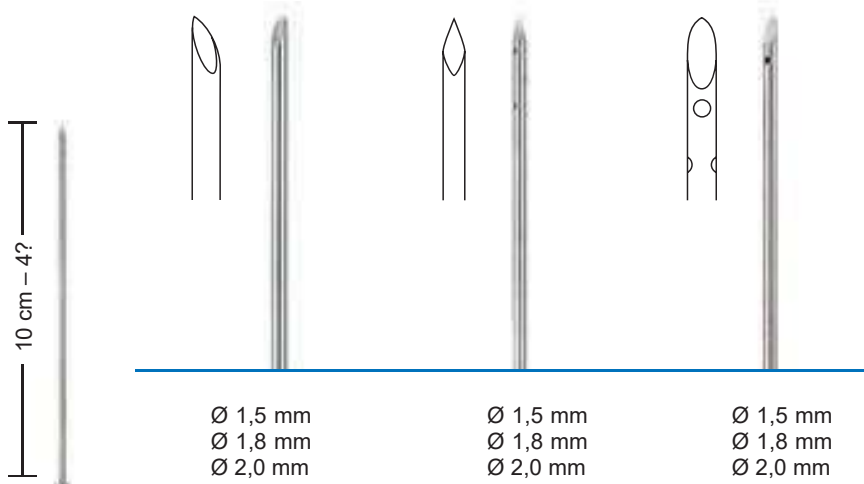

LICHTWITZ

LICHTWITZ-EICKEN

VOGEL



**TROCAR AND CANNULA**

SINUSCOPY O.D. 5MM,  
CANNULA 8.5CM

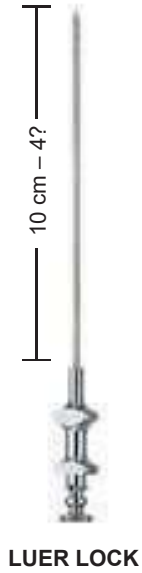

LUER LOCK

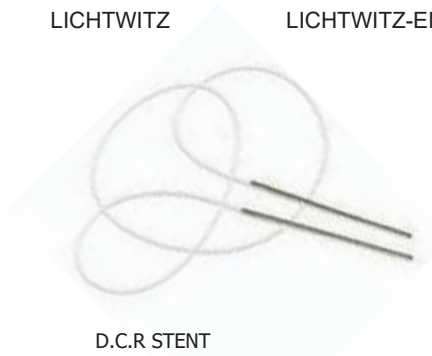

D.C.R. STENT



**D.C.R. DILATOR SET OF 3**



**D.C.R. PROBE SET OF 3**



**SINUS SICKLE KNIFE**



POINTED TIP



ROUND TIP



**DR. KIRTANE ELEVATOR WITH KNIFE**

# Sinuscopy Instruments

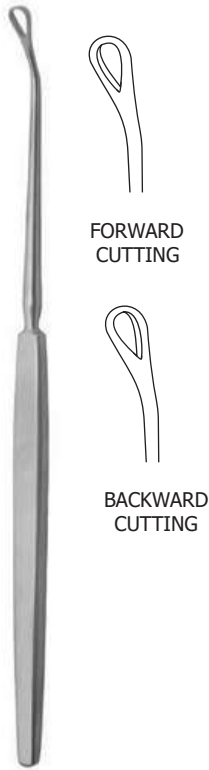

FORWARD CUTTING

BACKWARD CUTTING

**ANTRUM CURETTE**  
19CM



**SLIGHTLY CURVED SIMI ROUND**  
4X6MM

**MASING ELEVATOR WITH GRADUATED**



**SLIGHTLY CURVED FINE**  
3X5MM

**MASING ELEVATOR WITH GRADUATED**



**SMR ELEVATOR BROAD**  
4.5MM



**FREER ELEVATOR**



**ANTRUM CURETTE OVAL DOUBLE CURVED**  
19cm



2.5X4.0MM



4.0X9.0MM



**Large 450 Angled**  
(4.0 x 9.0 MM)



**Large 550 Angled**  
(2.5 x 6.0 MM)

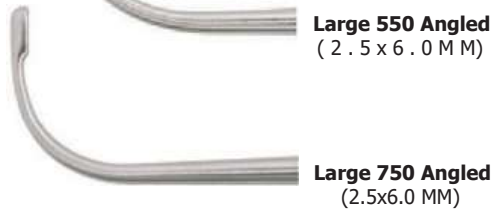

**Large 750 Angled**  
(2.5x6.0 MM)



**SICKLE KNIFE SUCTION**



**CURETTE SUCTION**



**ELEVATOR Suction**



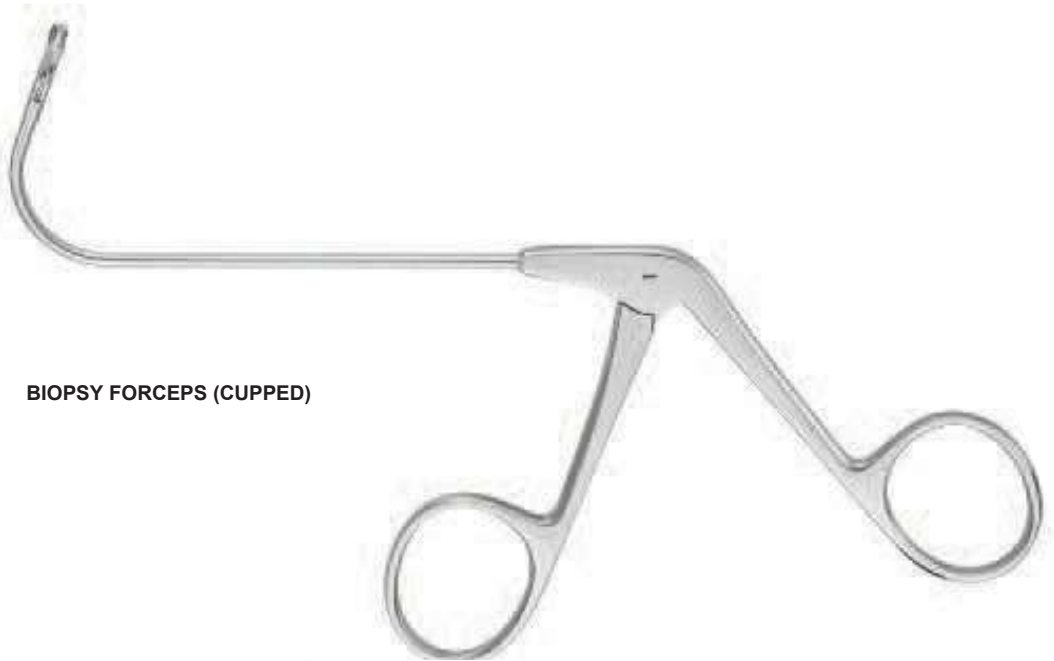

**BIOPSY FORCEPS (CUPPED)**



2,6 BACKWARD  
mm,110° HORIZONTAL 14,0 cm



2,6 mm,110° BACKWARD  
VERTICAL 14,0 cm



4 mm,110° UPWARD  
VERTICAL 14,0 cm



4 mm,110° UPWARD  
HORIZONTAL 14,0 cm



2,6 mm,70° UPWARD  
HORIZONTAL 14,0 cm



2,6 mm,70° UPWARD  
VERTICAL 14,0 cm



**BLAKESLEY NASAL FORCEPS**



Straight  
2.5MM  
3.0MM  
3.5MM  
5.0MM

Up 45°  
2.5MM  
3.0MM  
3.5MM  
5.0MM

Up 90°

Down



RIGHT  
3.5MM



LEFT  
3.5MM



**BLAKESLEY NASAL FORCEPS, WITH SUCTION**



Straight  
3.0MM

Up 45°  
3.0MM

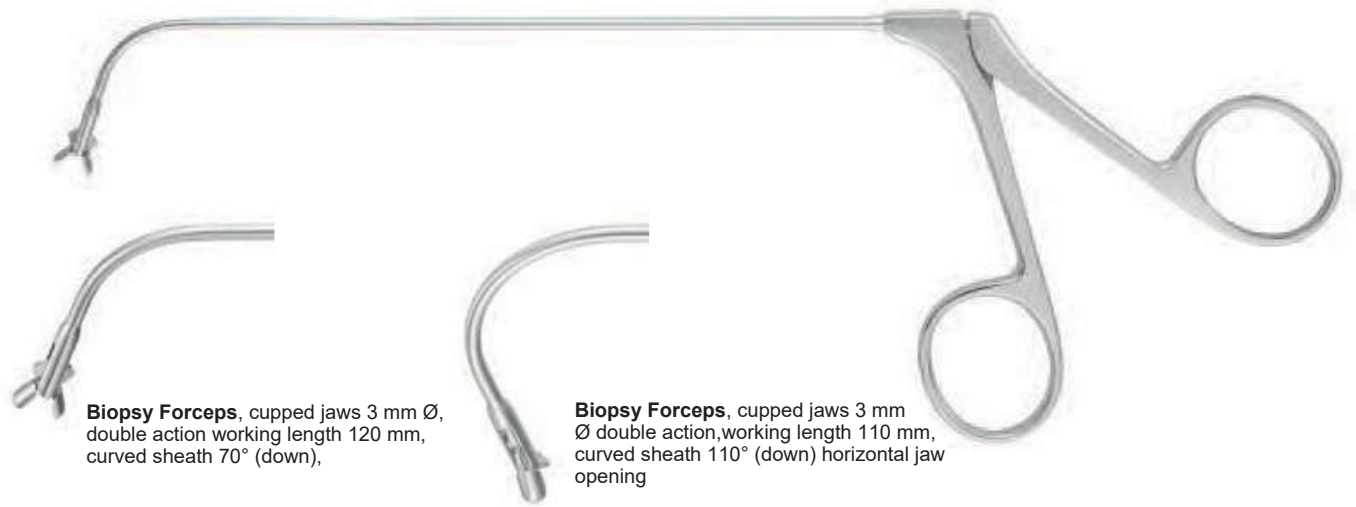

**Biopsy Forceps**, cupped jaws 3 mm Ø, double action working length 120 mm, curved sheath 70° (down),

**Biopsy Forceps**, cupped jaws 3 mm Ø double action, working length 110 mm, curved sheath 110° (down) horizontal jaw opening



**COBRA ,FRONTAL SINUS PUNCH, 70° UP-CURVED, 40° UP-BITING,**  
 WORKING LENGTH 130 MM, SLENDER  
 DESIGN WITH STRONG BITE TO AVOID TISSUE TRAUMA  
 DURING INSERTION THE INSTRUMENT SHOULD BE  
 LOCKED & THE JAWS CLOSED.

2MM  
 3MM



16CM

**CIRCULAR PUNCH, FULL 360° BITE**  
 CUTTING Ø3.5MM SHAFT UPTURNED 65° WORKING  
 LENGTH 160MM

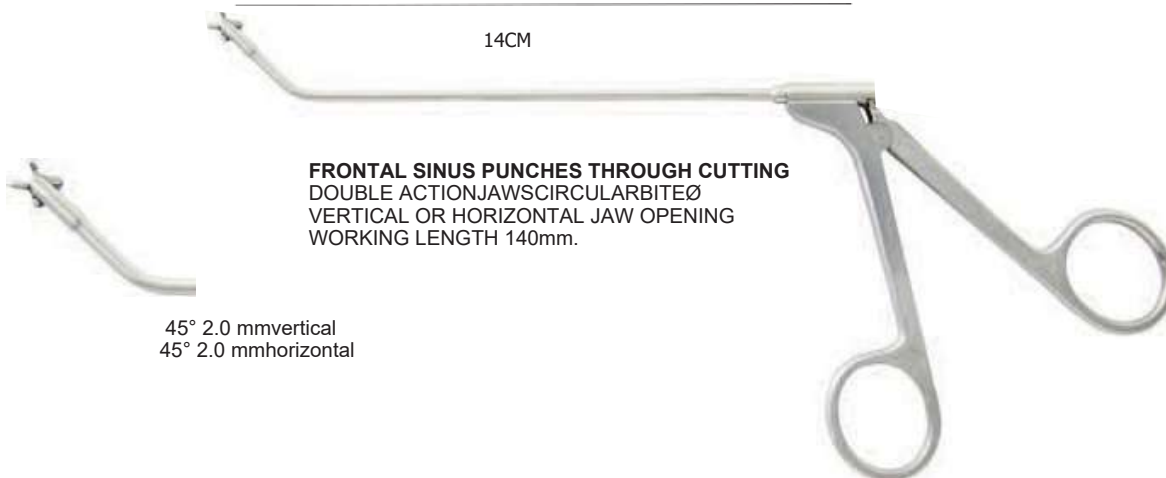

14CM

**FRONTAL SINUS PUNCHES THROUGH CUTTING**  
 DOUBLE ACTION JAW SCISSOR BITE Ø  
 VERTICAL OR HORIZONTAL JAW OPENING  
 WORKING LENGTH 140mm.

45° 2.0 mm vertical  
 45° 2.0 mm horizontal

14CM



Straight















Right



Left

**NASAL SCISSORS,  
SERRATED BLADES,**



	<b>STRAIGHT</b>	<b>RIGHT</b>	<b>LEFT</b>	<b>UP</b>
<b>GRASPER</b>				
	<b>LENGTH</b> 19cm	<b>LENGTH</b> 19cm	<b>LENGTH</b> 19cm	<b>LENGTH</b> 19cm
<b>CUP</b>				
	<b>LENGTH</b> 19cm	<b>LENGTH</b> 19cm	<b>LENGTH</b> 19cm	<b>LENGTH</b> 19cm
<b>SCISSOR</b>				
	<b>LENGTH</b> 19cm	<b>LENGTH</b> 19cm	<b>LENGTH</b> 19cm	<b>LENGTH</b> 19cm

14CM



Through cutting upper jaw, oval bite 1.5 mm, straight



Through cutting upper jaw, oval bite 1.5 mm, UPWARD



Through cutting upper jaw, oval bite 2.5 mm, straight



Through cutting upper jaw, oval bite 2.5 mm, UPWARD



Through cutting but bite 3.0 mm (oval) Straight



Through cutting but bite 3.0 mm (oval) UPWARD

### THROUGH CUTTING PUNCH



Through cutting but bite 3x9 mm Straight



Through cutting but bite 2.5 mm (oval) Straight, WITH SUCTION



Through cutting but bite 2.5 mm (oval) UPWARD WITH SUCTION

### THROUGH CUTTING PUNCH SUCTION



**Nasal Forceps by WIGAND,**  
through cutting, bite 11.5 x 2.5 mm (l x b),  
working length 140 mm, straight

**Nasal Forceps by WIGAND,**  
through cutting, bite 11.5 x 2.5 mm (l x b),  
working length 140 mm, 45° curved



**S-Bite, Nasal Forceps,** through cutting with serrated upper  
jaw, vertical, oval bite 2 mm, 70° curved upward (long  
curved), working length 130 mm.



**Nasal Forceps by TAKAHASHI,**  
working length 140 mm



Straight  
1MM  
2MM  
3MM  
4MM

Up 45°  
1MM  
2MM  
3MM  
4MM

DOWN  
1MM  
2MM  
3MM  
4MM



**UP BACK BITTING TOPI  
PUNCH**



**Antrum PUNCH UPSIDE BACKWARD CUTTING,  
2.5MM BITE ADULT SIZE WORKING LENGTH 140MM**

UP

DOWN

LEFT

RIGHT



**ROTATING ANTRUM PUNCH BACKWARD CUTTING  
BITE 2.5MM WORKING LENGTH 100MM (360° ROTATING  
SYSTEM WITH LOCKING MECHANISM)**

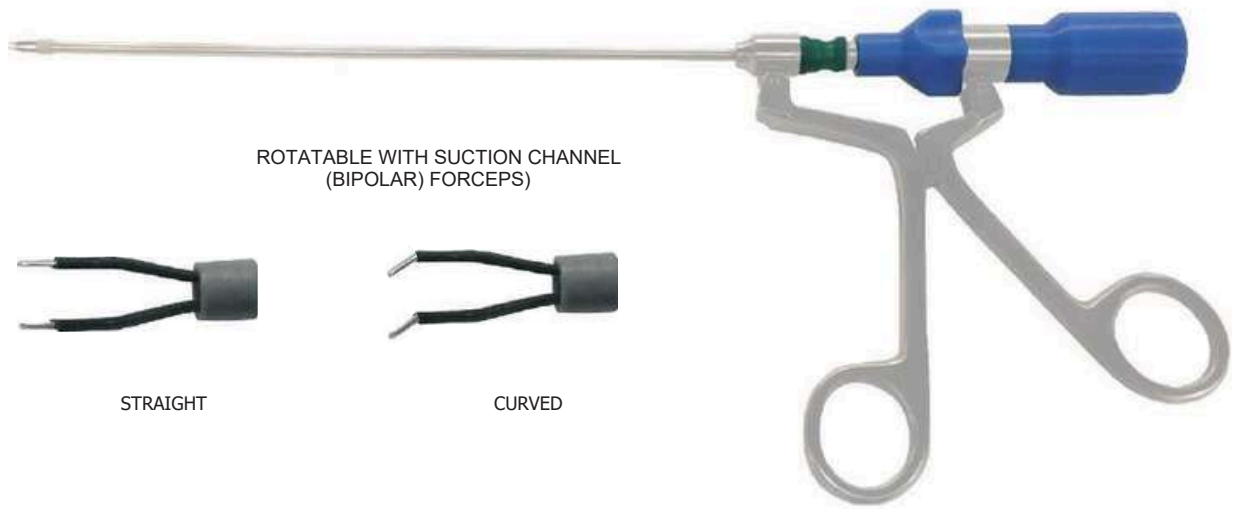

ROTATABLE WITH SUCTION CHANNEL  
(BIPOLAR) FORCEPS



STRAIGHT



CURVED

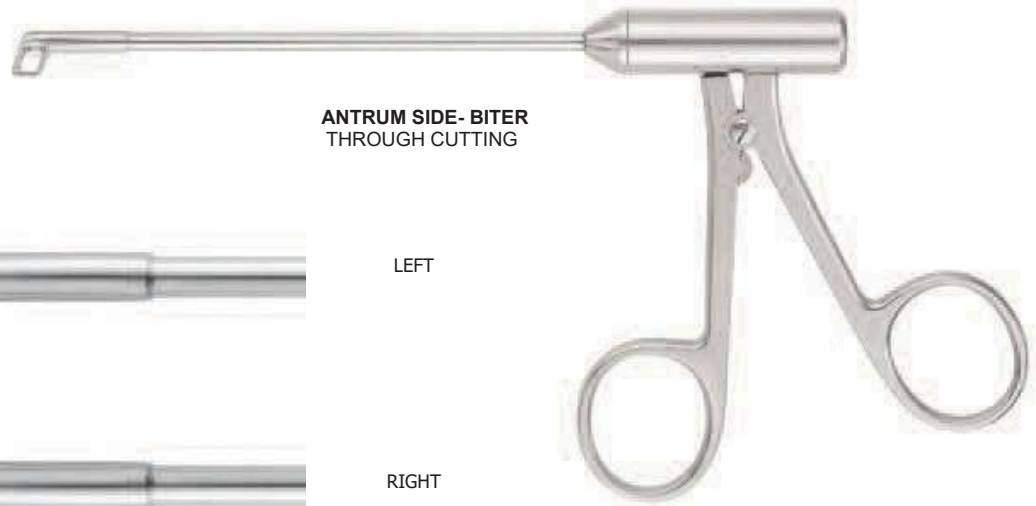

ANTRUM SIDE-BITER  
THROUGH CUTTING



LEFT



RIGHT

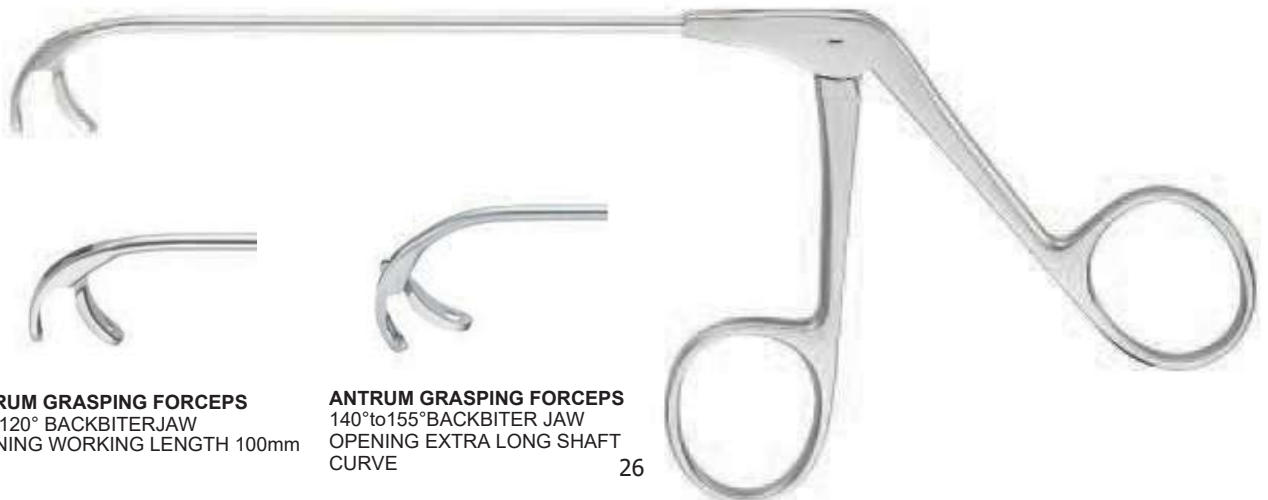

**ANTRUM GRASPING FORCEPS**  
90° to 120° BACKBITER JAW  
OPENING WORKING LENGTH 100mm

**ANTRUM GRASPING FORCEPS**  
140° to 155° BACKBITER JAW  
OPENING EXTRA LONG SHAFT  
CURVE

# Sinuscopy Instruments



PEDIATRIC  
Straight



PEDIATRIC  
Up 45°



**THROUGH CUTTING**  
PUNCH PEDIATRIC



PEDIATRIC  
Straight



PEDIATRIC  
Up 45°



**THROUGH CUTTING** Punch



PEDIATRIC FINE  
Straight  
1.5MM



PEDIATRIC FINE  
Up 45°  
1.5MM



**BLAKESLEY NASAL** FORCEPS



PEDIATRIC  
UP 2MM



PEDIATRIC  
DOWN 2MM

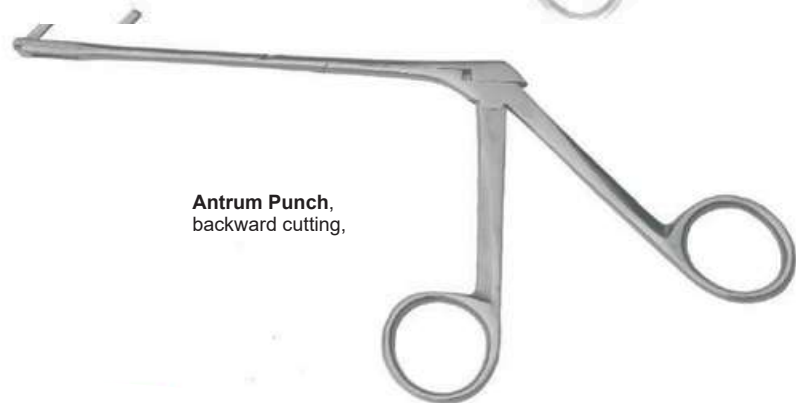

**Antrum Punch,**  
backward cutting,



**ANTRUM PUNCH**  
THROUGH-CUTTING WITH RESERVOIR to PICKUP and COLLECT BONE MATERIAL

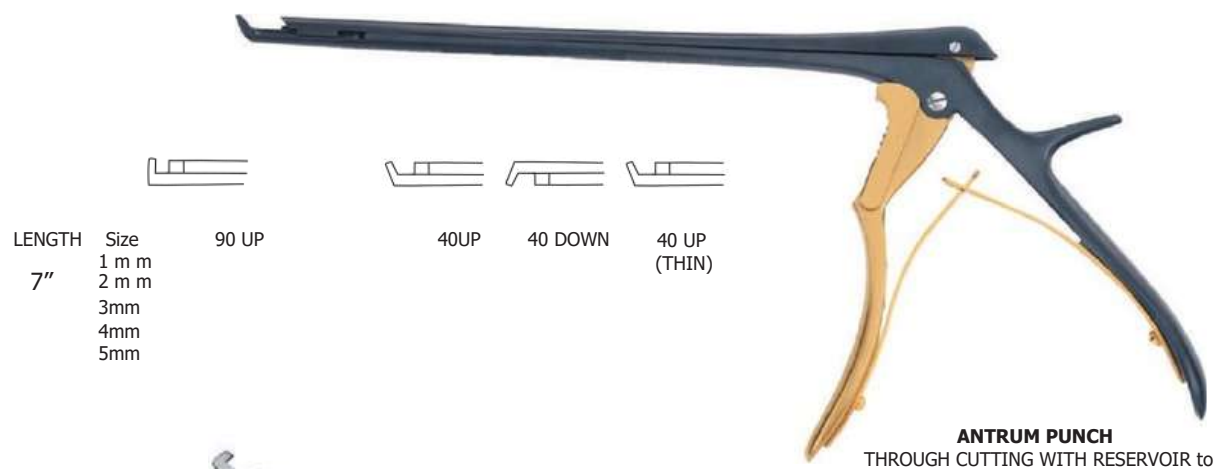

**ANTRUM PUNCH**  
THROUGH CUTTING WITH RESERVOIR to PICKUP and COLLECT BONE MATERIAL  
**(BLACK COATED)**

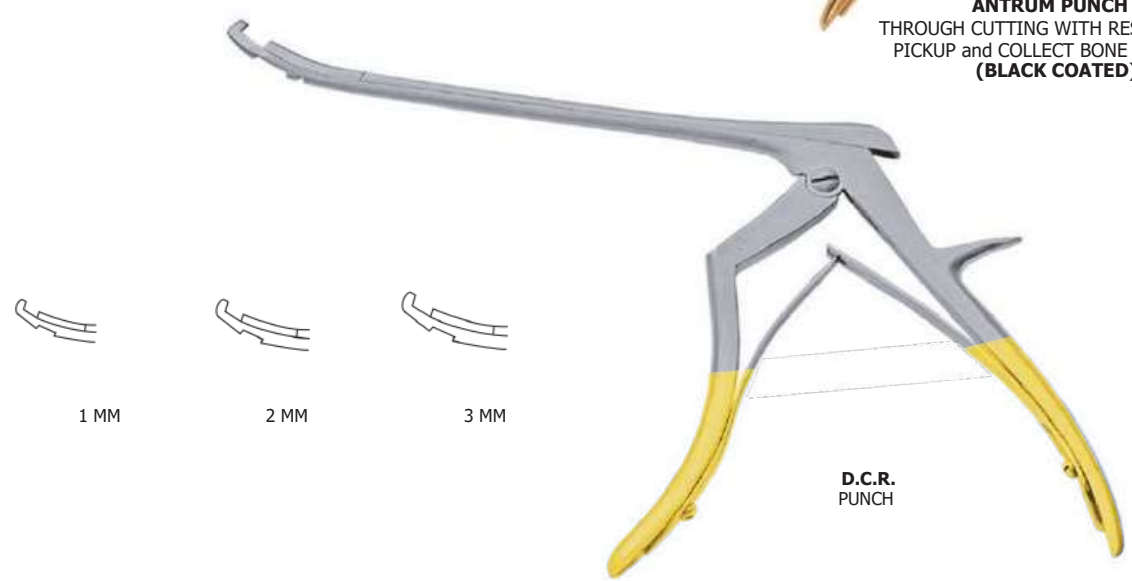

**D.C.R. PUNCH**

## INSTRUMENTS FOR TRAINING



**NASAL SCISSORS,  
SERRATED BLADES,**

## INSTRUMENTS FOR TRAINING

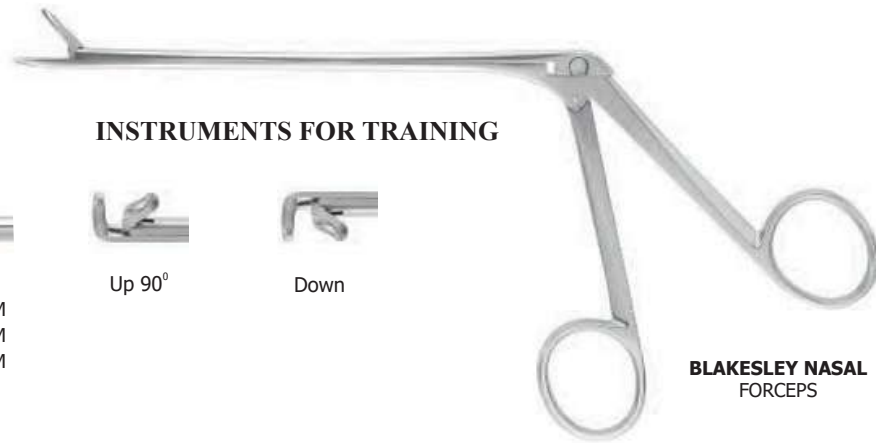

**BLAKESLEY NASAL  
FORCEPS**

## INSTRUMENTS FOR TRAINING



**THROUGH CUTTING  
PUNCH**

## INSTRUMENTS FOR TRAINING

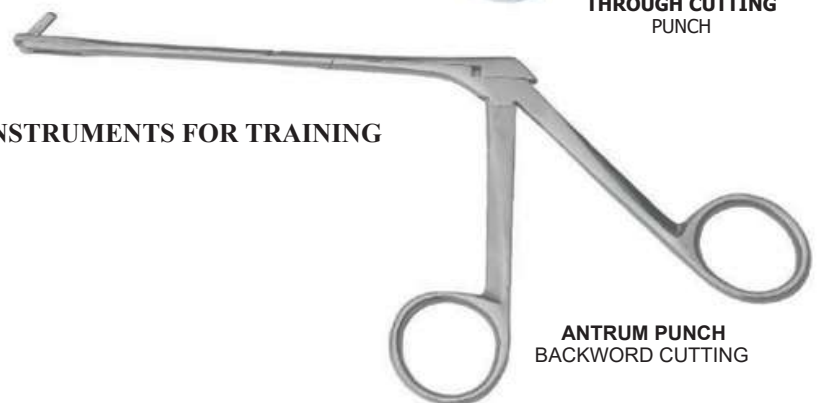

**ANTRUM PUNCH  
BACKWARD CUTTING**



## MICRO DISC RONGEUR FINE SHAFT

SHAFT LENGTH	BITE SIZE
6"	1.5mm
7"	1.5mm

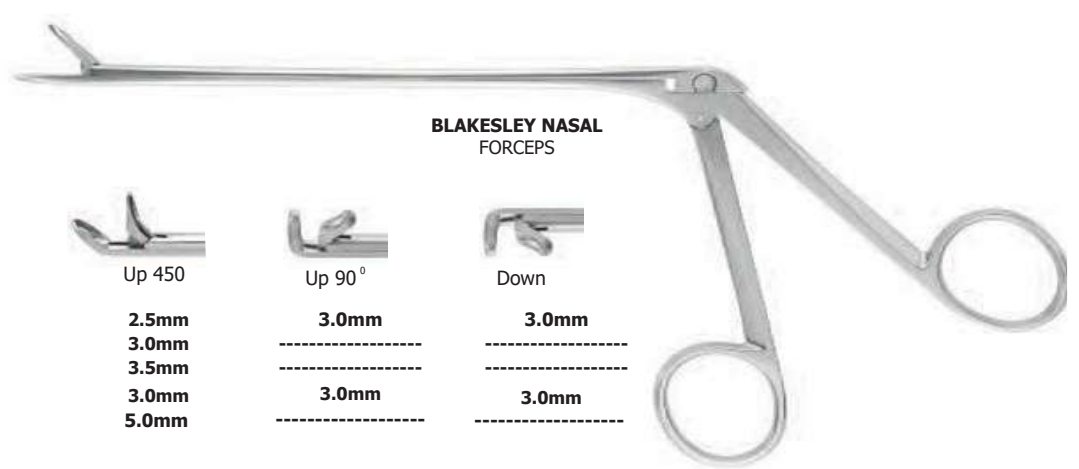

## BLAKESLEY NASAL FORCEPS

	Straight	Up 45°	Up 90°	Down
13 CM	2.5mm	2.5mm	3.0mm	3.0mm
13 CM	3.0mm	3.0mm	-----	-----
13 CM	3.5mm	3.5mm	-----	-----
18 CM	3.0mm	3.0mm	3.0mm	3.0mm
18 CM	5.0mm	5.0mm	-----	-----



18 CMN-10533 3.0mm RIGHT



18 CMN-10531 3.0mm,LEFT

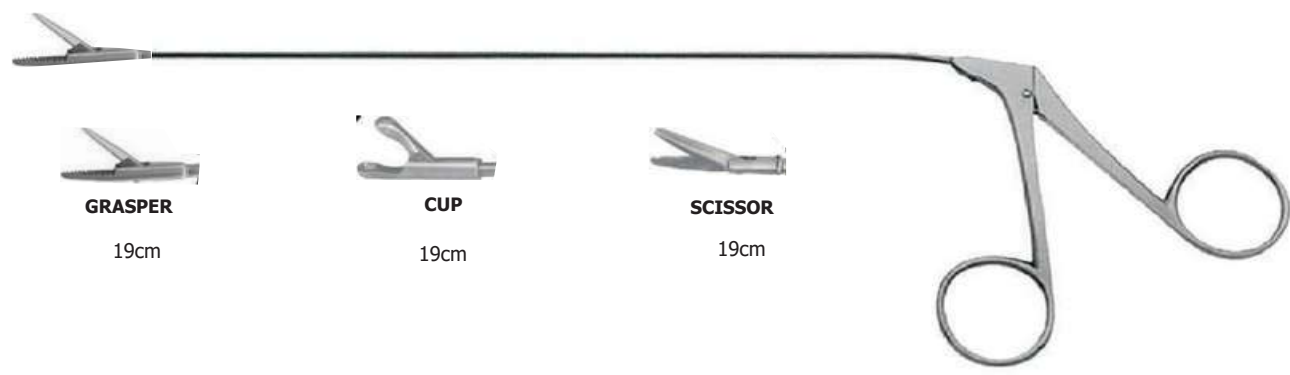

**GRASPER**  
19cm

**CUP**  
19cm

**SCISSOR**  
19cm

# Skull Base Instruments



**TITANIUM**

JACOBSON MICRO VESSEL ARACHNOIDS KNIFE 18,5 cm – 7¼"

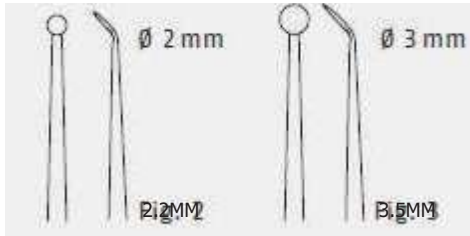

MICRO RASPATORY ROUND BLADE **SHARP**  
23 cm – 9"

**TITANIUM**

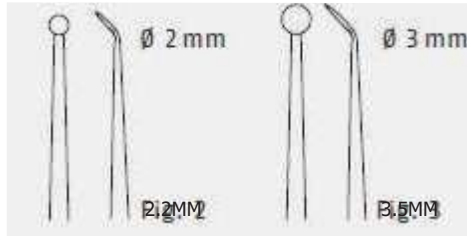

MICRO RASPATORY ROUND BLADE **BLUNT**  
23 cm – 9"

**TITANIUM**

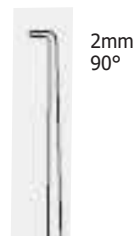

MICRO HOOKS **BLUNT** 23CM – 9"

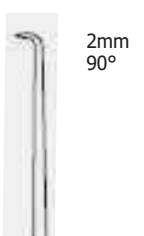

MICRO HOOKS **SHARP** 23CM – 9"



YASARGIL MICRO RASPATORY ANGLED  
18,5 cm – 7¼"

**TITANIUM**

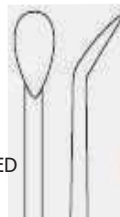

YASARGIL MICRO RASPATORY ANGLED 2.5mm  
18,5 cm – 7¼"

**TITANIUM**



YASARGIL MICRO RASPATORY SLIGHTLY CURVED  
3.5mm, 18,5 cm – 7¼"

**TITANIUM**



YASARGIL MICRO RASPATORY STRONGLY CURVED  
3.5mm, 18,5 cm – 7¼"

**TITANIUM**



HORIZONTAL



VERTICAL

RAY CURETTE 18.0cm 7"

# Skull Base Instruments

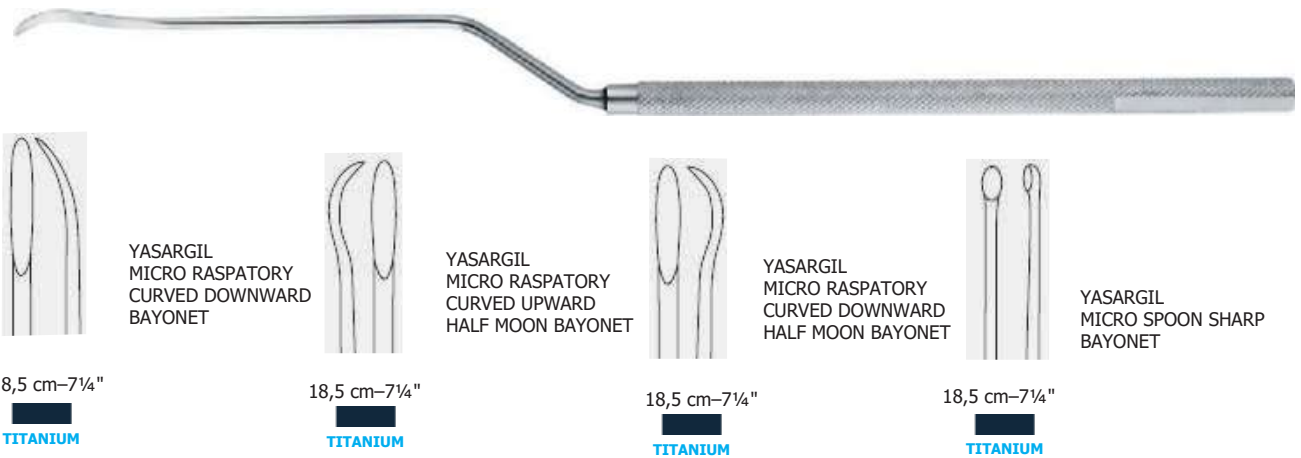
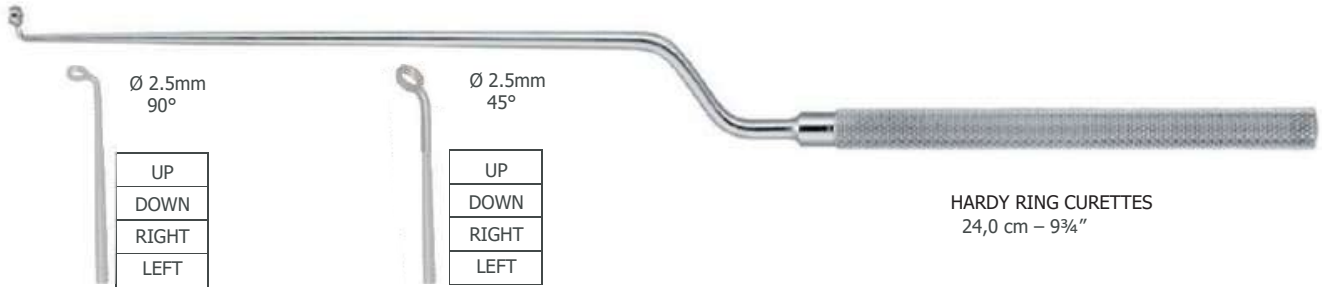

# Skull Base Instruments

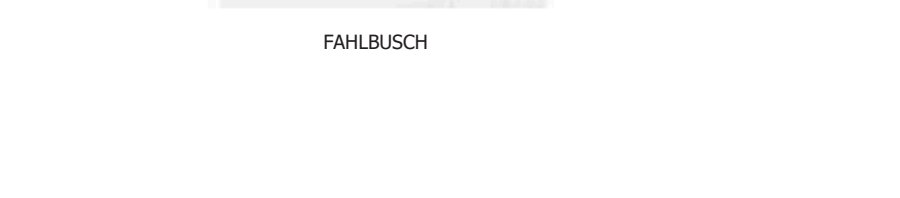
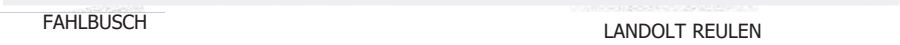
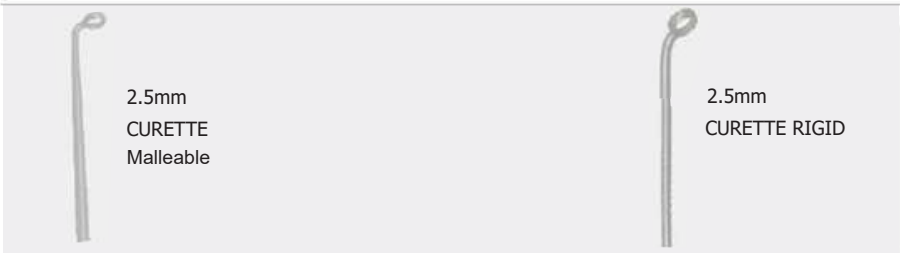
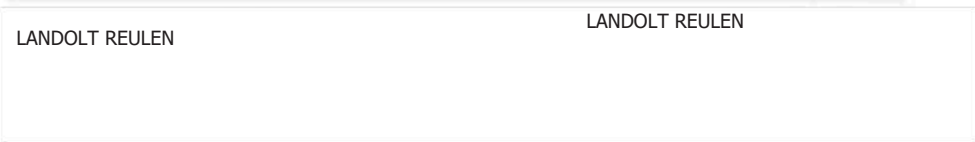
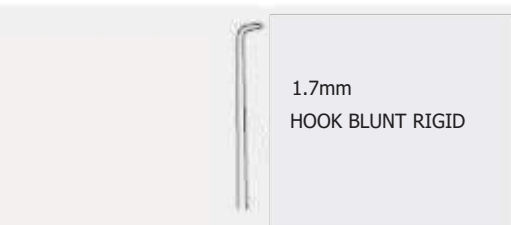

# Skull Base Instruments



RHOTON TYPE  
DISSECTORS  
7½"



BLADE 1.5mm DISSECTORS	BLADE 2.3mm	BLADE 3.3mm	CURVED ELEVATORS	ANGLED ELEVATORS
------------------------------	----------------	----------------	---------------------	---------------------

STAINLESS STEEL  
TITANIUM



SMALL 1.1mm	MEDIUM 1.7mm	LARGE 2.7mm	SEMI-SHARP HOOK	BLUNT HOOK
----------------	-----------------	----------------	--------------------	---------------

STAINLESS STEEL  
TITANIUM



SEMI SHARP 45° HOOK	STRAIGHT NEEDLE	STRAIGHT CURETTES	ANGLED CURETTES	TEARDROP DISSECTOR 0° STRAIGHT	TEARDROP DISSECTOR 90° 3mm
---------------------------	--------------------	----------------------	--------------------	--------------------------------------	----------------------------------

STAINLESS STEEL  
TITANIUM



TEARDROP DISSECTOR 5mm 90°	TEARDROP DISSECTOR 4mm 40°	TEARDROP DISSECTOR 8mm 40°
----------------------------------	-------------------------------------	-------------------------------------

STAINLESS STEEL  
TITANIUM

# Skull Base Instruments

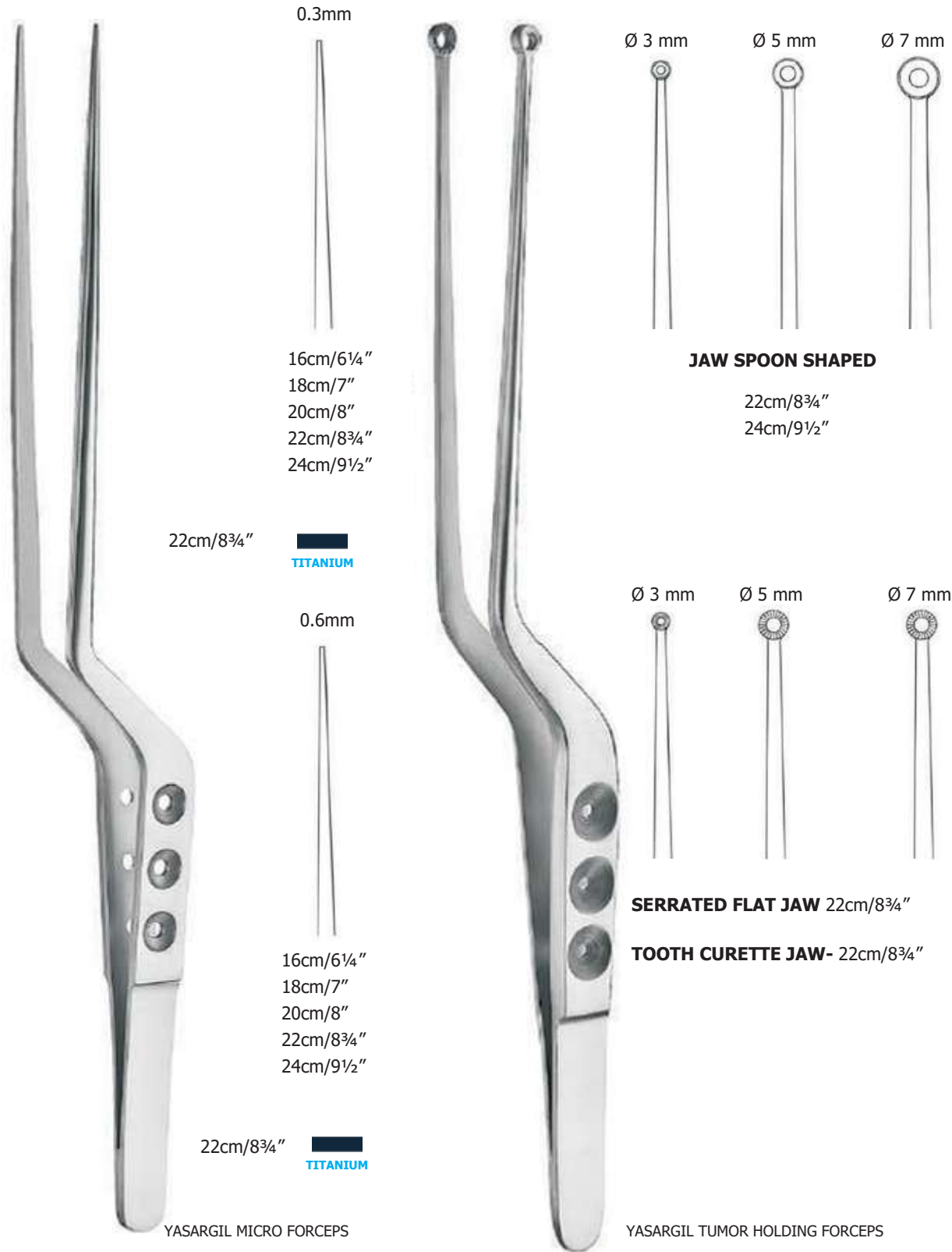

# Skull Base Instruments

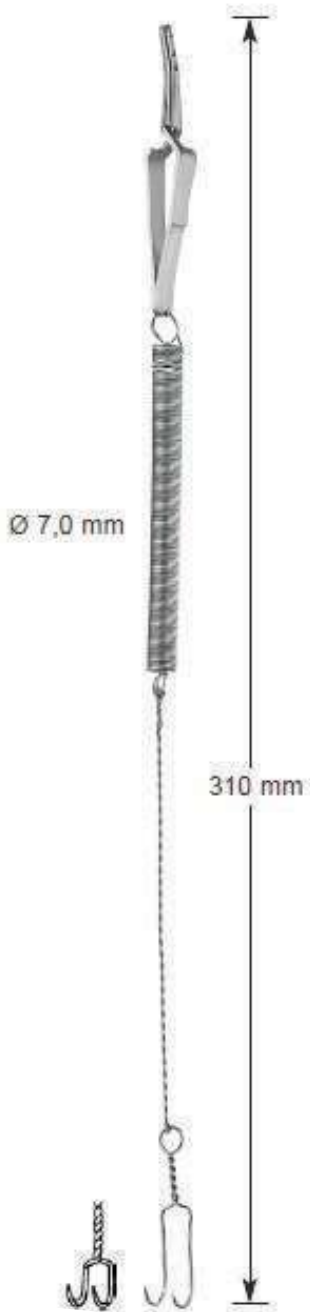

**YASARGIL GALEA FISH HOOK WITH SPRING**

31cm/12¼"



**DOWNWARD**  
22.5cm/9"



**UPWARD**  
22.5cm/9"  
24.5cm/9¾"

22.5cm/9"



T.C



TITANIUM

22.5cm/9"



**STRAIGHT**

22.5CM

24.5CM

22.5CM



T.C

T.C



TITANIUM

22.5cm/9"



**YASARGIL MICRO SCISSORS BAYONET SHAPE**

**SUCTION CANNULAS WITH IRRIGATION KEY HOLE**  
(Special design for skull base surgery)



SIZE  
5X4 MM  
4X3MM  
3X2MM  
2X1MM

**SUCTION CANNULAS WITH KEY HOLE**

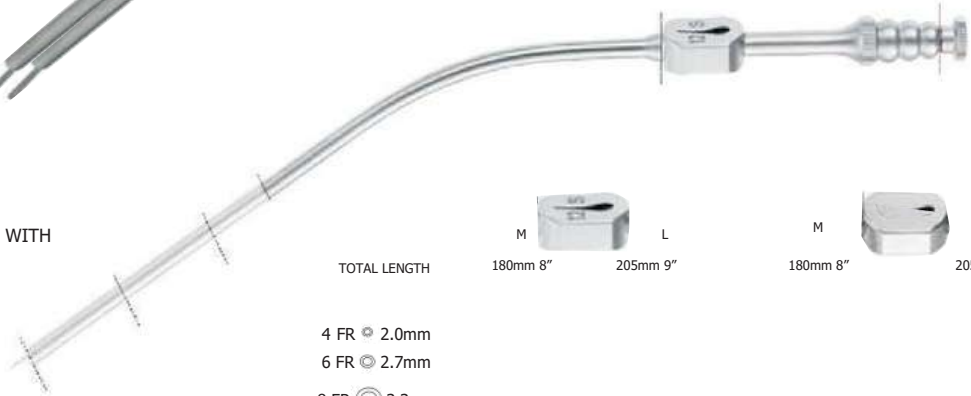

TOTAL LENGTH

M 180mm 8" L 205mm 9"

M 180mm 8" L 205mm 9"

- 4 FR  $\odot$  2.0mm
- 6 FR  $\odot$  2.7mm
- 8 FR  $\odot$  3.3mm
- 10 FR  $\odot$  4.0mm
- 12 FR  $\odot$  4.5mm

**SUCTION CANNULAS WITH KEY HOLE**

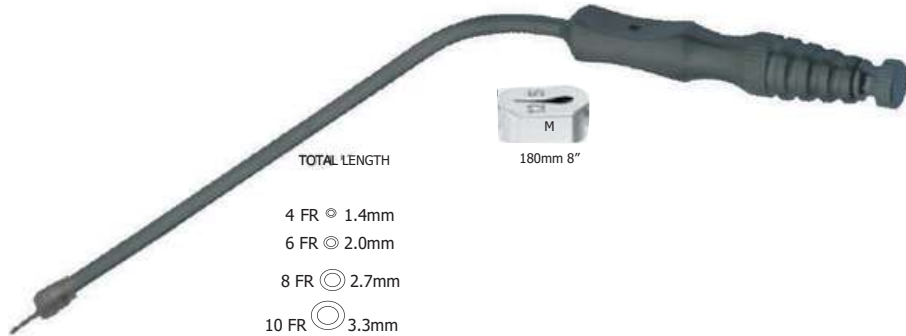

TOTAL LENGTH

M 180mm 8"

- 4 FR  $\odot$  1.4mm
- 6 FR  $\odot$  2.0mm
- 8 FR  $\odot$  2.7mm
- 10 FR  $\odot$  3.3mm

**SUCTION CANNULAS CURVED SUCTION INSTRUMENTS**

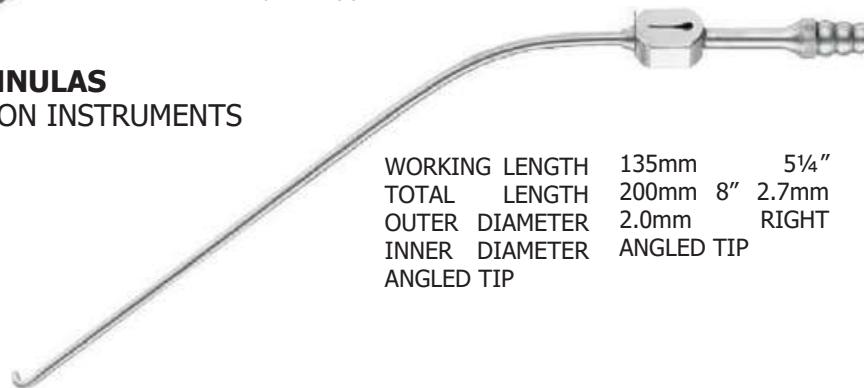

WORKING LENGTH	135mm	5 1/4"	135mm	5 1/4"
TOTAL LENGTH	200mm	8" 2.7mm	200mm	8" 2.7mm
OUTER DIAMETER	2.0mm	RIGHT	2.0mm	LEFT
INNER DIAMETER	ANGLED TIP		ANGLED TIP	

# Tonsillectomy instruments



**TONGUE DEPRESSOR**

SIZE 1  
SIZE 2  
SIZE 3



**NEGUS TONSIL**  
ARTERY FORCEPS  
HALF CURVED

**NEGUS TONSIL**  
ARTERY FORCEPS  
FULL CURVED

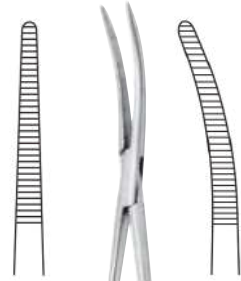

**STRAIGHT**

**CURVED**

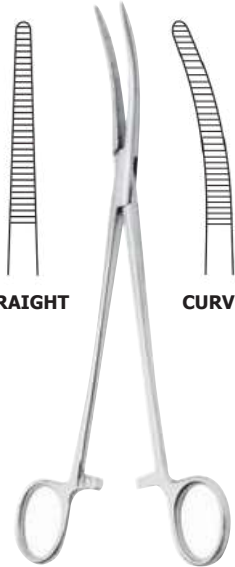

**BIRKETT TONSIL**  
ARTERY FORCEPS



6"  
7"  
8"  
S.S  
**TONSIL FINE**  
METZENBAUM  
SCISSORS CURVED

6"  
7"  
8"  
**TONSIL FINE**  
METZENBAUM SCISSORS  
STRAIGHT

S.S



6"  
7"  
8"  
T.C  
**TONSIL FINE**  
METZENBAUM  
SCISSORS CURVED

6"  
7"  
8"  
**TONSIL FINE**  
METZENBAUM SCISSORS  
STRAIGHT

T.C



6'  
7'  
S.C  
**TONSIL FINE**  
METZENBAUM  
SCISSORS CURVED

6'  
7'  
**TONSIL FINE**  
METZENBAUM SCISSORS  
STRAIGHT

S.C



**WILSON**  
ARTERY FORCEPS

# Tonsillectomy instruments



**DENIS BROWNE**  
TONSIL HOLDING FORCEPS



**COLVER TONSIL**  
HOLDING FORCEPS



**TONSIL**  
NEEDLE HOLDER  
S.S



**TONSIL**  
NEEDLE HOLDER  
TUNGSTEN CARBIDE



**NEGUS PUSHER**  
KNOT TIER



**EVE TONSIL**  
SNARE



**WIRE**



**HURD TONSIL**  
DISSECTOR



**HANKE TONSIL**  
DISSECTOR ONE  
SIDE SERRATED



**TONSIL PILLAR**  
RETRACTOR & DISSECTOR

# Tonsillectomy instruments



**TONSIL NEEDLE**  
RIGHT



**TONSIL NEEDLE**  
LEFT



**KNIFE**



**TONGUE TIE**  
PROBE



**YANKAUER TONSIL**  
SUCTION TUBE



**BACKMANN**  
ADENOID CURETTE

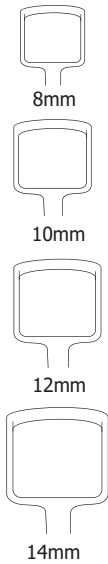

**ST. CLAIR THOMPSON**  
ADENOID CURETTE  
WITH CAGE

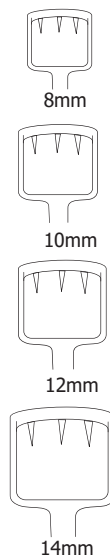

**WAUGH TONSIL**  
DISSECTION FORCEPS



**WAUGH TONSIL**  
DISSECTION FORCEPS  
**PLAIN**      **TOOTH**

# Tonsillectomy instruments



**BOYLE DAVIS MOUTH GAG**  
WITH 3 TONGUE PLATES - **CHILD**



**BOYLE DAVIS MOUTH GAG**  
WITH 4 TONGUE PLATES - **ADULT**



**DOUGHTY SLOTTED MOUTH GAG**  
WITH 4 TONGUE PLATES

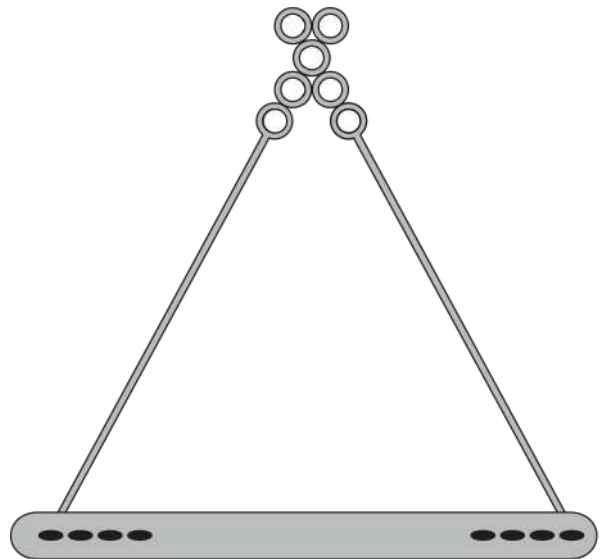

**DRAFFIN BIPOD STAND**  
WITH PLATES

# Tonsillectomy instruments



**DINGMAN MOUTH GAG**  
WITH 3 TONGUE PLATES

**DINGMAN MOUTH GAG**  
WITH 3 TONGUE PLATES  
(FIBER OPTIC LIGHT CARRIER)



**DOYAN MOUTH GAG**

ADULT  
CHILD



**HEISTER**  
MOUTH GAG



**JENNINGS**  
MOUTH GAG



**Tonsil Needle, Luer-Lock,**  
Straight, 0.8 mm



**Tonsil Needle, Luer-Lock,**  
Angled, 0.8 mm

# Larynx / Tracheotomy



**BRASS**

- 1
- 2
- 3
- 4
- 5

**STAINLESS STEEL**

- 1
- 2
- 3
- 4
- 5



**BRASS**

- 1
- 2
- 3
- 4
- 5

**STAINLESS STEEL**

- 1
- 2
- 3
- 4
- 5



**BRASS**

**STAINLESS STEEL**



**POST RHINOSCOPIC MIRROR WITHOUT HANDLE**

**MIRROR HANDLE**

**TONGUE HOLDING FORCEPS**



**LANGEN BECK RETRACTOR**  
SMALL  
MEDIUM



**VOLKMANN RETRACTORS**  
3 PRONGS  
4 PRONGS

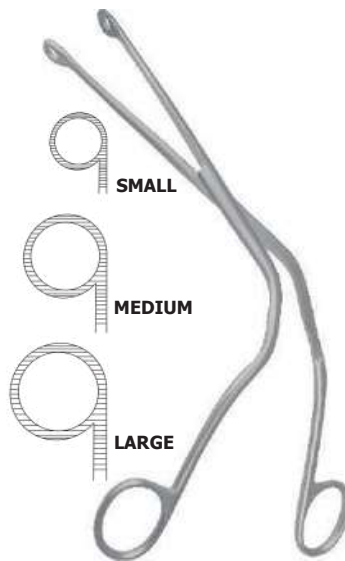

**SMALL**

**MEDIUM**

**LARGE**

**MAGILL INTRATRACHEAL CATHETER FORCEPS**



**TRACHEAL DILATING FORCEPS**

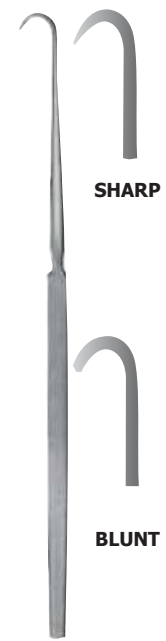

**SHARP**

**BLUNT**

**TRACHEAL RETRACTOR**  
1 PRONG SHARP



**TRACHEAL RETRACTOR**  
2 PRONGS BLUNT

# Larynx / Trachetomy



**FIBER OPTIC  
FLEXIBLE LARYNGOSCOPE  
SET OF 3**



**FULLER TRACHEOTOMY**  
TUBE ALL METAL  
18FG  
20FG  
22FG  
24FG  
26FG  
28FG  
30FG  
32FG  
34FG  
36FG



**JACKSON TRACHEOTOMY**  
TUBE ALL METAL  
12FG 2 8 F  
14FG G 3 0  
16FG F G 3  
18FG 2 F G  
20FG 3 4 F  
22FG G 3 6  
24FG F G 3  
26FG 8 F G  
4 0 F  
G 4 2  
F G



**MAGILL LARYNGOSCOPE  
WITH BLADES**  
  
SET OF 2 BLADES  
SET OF 3 BLADES  
SET OF 4 BLADES



**McINTOSH LARYNGOSCOPE  
WITH BLADES**  
  
SET OF 3 BLADES  
SET OF 4 BLADES



**FIBER OPTIC LARYNGOSCOPE  
SET OF 3 BLADES**



**NEGUS ANTERIOR  
COMMISURE LARYNGOSCOPE**  
with LONG CUT with FIBER  
OPTIC CARRIER

**HYPO PHARYNGOSCOPE with  
FIBER OPTIC CARRIER**  
CHILD  
ADULT

**ANTERIOR COMMISURE  
LARYNGOSCOPE with FIBER  
OPTIC CARRIER**  
PEDIATRIC  
MEDIUM  
LARGE

**ANTERIOR COMMISURE  
LARYNGOSCOPE with  
DOWN EDGE**

**ANTERIOR COMMISURE  
LARYNGOSCOPE with  
ENDOSCOPE CARRIER**

**WEERDA DISTENDING  
OPERATING LARYNGOSCOPE**  
LARGE ADULT SIZE F.O.L.L.,  
INJECTION CANNULA INSERTABLE  
SUCTION TUBE

**JACKSON LARYNGOSCOPE**  
ADULT with FIBER OPTIC  
CARRIER

**LARYNGOSCOPE  
HOLDER and CHEST SUPPORT**



**LARYNGEAL SUCTION**  
TUBE 25CM  
1No. 2 No  
3No. . 4 N  
o .

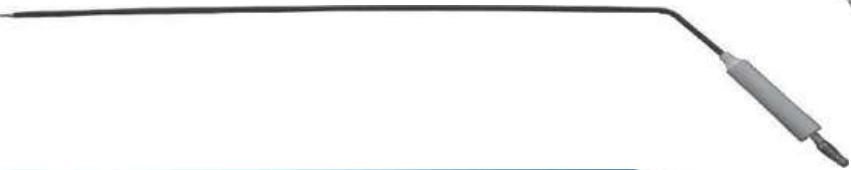

**MONOPOLAR LARYNGEAL NEEDLE**



**MONOPOLAR LARYNGEAL SUCTION TUBE**



**SUCTION RASPATORY, NEEDLE STRAIGHT, 23 CM**



**LARYNGEAL FORCEPS, TUBULAR MODEL, CURVED, OVAL CUPS**



**LARYNGEAL FORCEPS, TUBULAR MODEL, CURVED, ALLIGATOR**



PICK 90  
MICRO LARYNGEAL  
SWAB HOLDER  
MICRO LARYNGEAL  
MICRO LARYNGEAL KNIFE STRAIGHT  
PROBE 90  
MICRO LARYNGEAL  
PROBE STRAIGHT  
MICRO LARYNGEAL  
PLESTER OVAL KNIFE  
MICRO LARYNGEAL  
ROUND KNIFE 45°  
MICRO LARYNGEAL  
PEELING KNIFE  
MICRO LARYNGEAL  
SICKLE KNIFE CURVED  
MICRO LARYNGEAL  
MICRO LARYNGEAL HANDLE



**UNIPOLAR COAGULATION**  
FORCEPS, ROTATABLE,  
SERRATED, 25cm

**UNIPOLAR COAGULATION**  
FORCEPS, ROTATABLE,  
CUP, 25cm

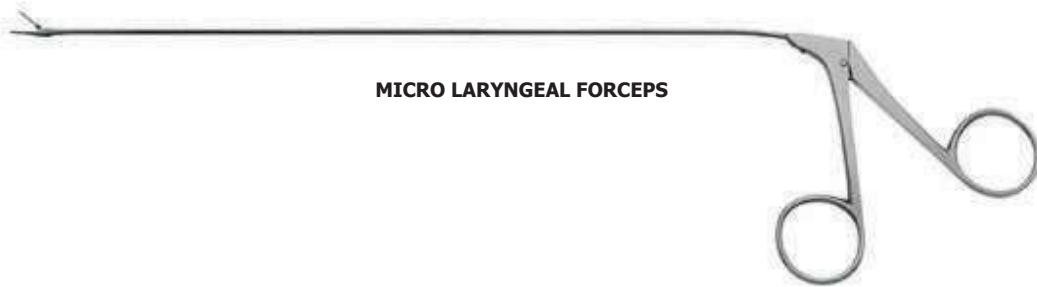

**MICRO LARYNGEAL FORCEPS**



**MICRO LARYNGEAL**  
FORCEPS SERRATED JAW  
25cm  
35cm



**MICRO LARYNGEAL**  
FORCEPS SERRATED JAW  
CURVED RIGHT 25CM



**MICRO LARYNGEAL**  
FORCEPS SERRATED JAW  
CURVED LEFT SIZE 25CM



**MICRO LARYNGEAL**  
FORCEPS SERRATED JAW  
UPWARD SIZE 25cm



**MICRO LARYNGEAL**  
FORCEPS CUP JAW STRAIGHT  
25CM  
35CM



**MICRO LARYNGEAL**  
FORCEPS CUP JAW CURVED RIGHT  
SIZE 25CM



**MICRO LARYNGEAL**  
FORCEPS CUP JAW CURVED LEFT  
SIZE 25CM



**MICRO LARYNGEAL**  
FORCEPS CUP JAW  
UPWARD SIZE 25CM



**MICRO LARYNGEAL**  
SCISSORS STRAIGHT  
SIZE 25CM



**MICRO LARYNGEAL**  
SCISSORS CURVED RIGHT  
SIZE 25CM **RIGHT**  
SIZE 25CM **LEFT**



**MICRO LARYNGEAL**  
SCISSORS CURVED RIGHT  
SIZE 25CM **UP**



**PATTERSON BIOPSY**  
FORCEPS  
SIZE 25CM  
SIZE 35CM  
SIZE 45CM  
SIZE 55CM



**JACKSON GRASPING**  
FORCEPS  
SIZE 25CM  
SIZE 35CM  
SIZE 45CM  
SIZE 55CM



**JACKSON FOREIGN**  
BODY FORCEPS  
SIZE 25CM  
SIZE 35CM  
SIZE 45CM  
SIZE 55CM



**VOCAL NODULE FORCEPS**  
SIZE 25CM  
SIZE 35CM  
SIZE 45CM  
SIZE 55CM



**BIOPSY PUNCH**  
FORCEPS  
SIZE 25CM  
SIZE 35CM  
SIZE 45CM  
SIZE 55CM

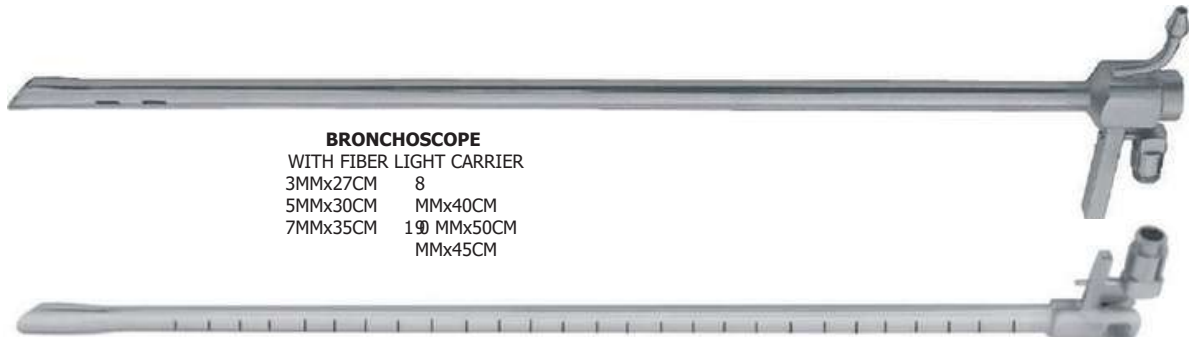

**BRONCHOSCOPE**  
WITH FIBER LIGHT CARRIER  
3MMx27CM 8  
5MMx30CM 11MMx40CM  
7MMx35CM 14MMx50CM  
MMx45CM



**ESOPHAGOSCOPE**  
WITH FIBER LIGHT CARRIER  
3MMx5MMx27CM 8MMx12MMx40CM  
6MMx8MMx30CM 10MMx14MMx45CM  
8MMx10MMx35CM 12MMx16MMx50CM



**BRONCHOSCOPE**  
SUCTION TUBES  
35CM  
45CM  
55CM

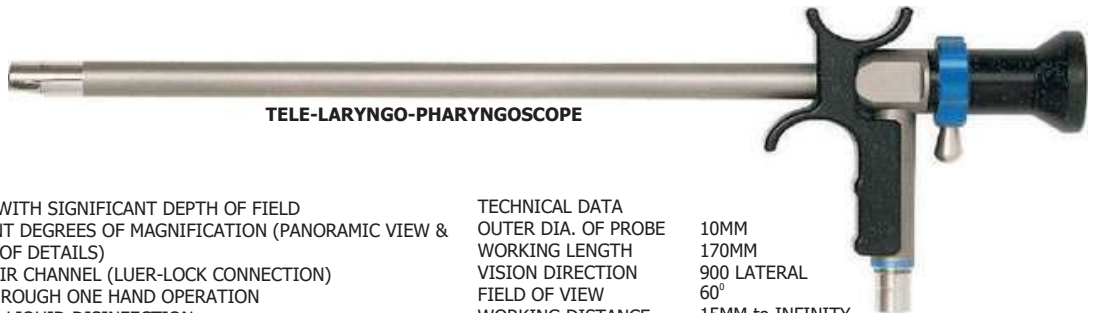

**TELE-LARYNGO-PHARYNGOSCOPE**

**FEATURES :**

- SHARP IMAGE WITH SIGNIFICANT DEPTH OF FIELD
- TWO DIFFERENT DEGREES OF MAGNIFICATION (PANORAMIC VIEW & EXAMINATION OF DETAILS)
- INTEGRATED AIR CHANNEL (LUER-LOCK CONNECTION)
- FOCUSABLE THROUGH ONE HAND OPERATION
- SOAKABLE FOR LIQUID DISINFECTION
- INTEGRATED FIBER OPTIC ILLUMINATION SYSTEM

**TECHNICAL DATA**  
OUTER DIA. OF PROBE 10MM  
WORKING LENGTH 170MM  
VISION DIRECTION 90° LATERAL  
FIELD OF VIEW 60°  
WORKING DISTANCE 15MM to INFINITY



**FLEXIBLE RHINO LARYNGO PHARYNGOSCOPE**

**TECHNICAL DATA**

Outer diameter of flexible probe 3,8 mm  
Length 300 mm  
Vision Direction 0° direct  
Field of view 85°  
Angulation 2-way each app. 150°  
Working distance 3 mm to infinity

# Micro Scissors

## MICRO SPRING SCISSORS FLAT HANDLE

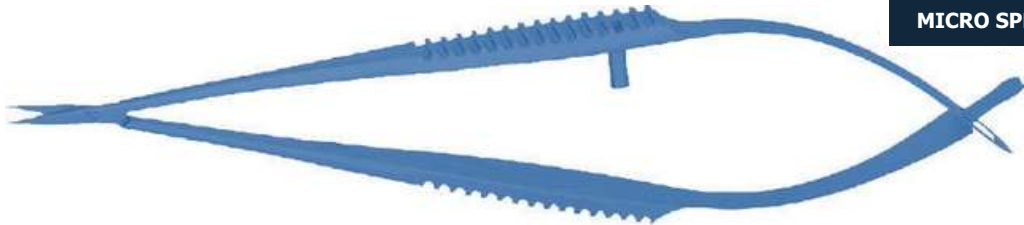

SIZE	6"
S.S	
T.C	
TITANIUM	

SIZE  
6"  
6"  
6"

SIZE	7"
S.S	
T.C	
TITANIUM	

SIZE  
7"  
7"  
7"

SIZE	8"
S.S	
T.C	
TITANIUM	

SIZE  
8"  
8"  
8"

## MICRO SCISSORS SPRING ROUND HANDLE

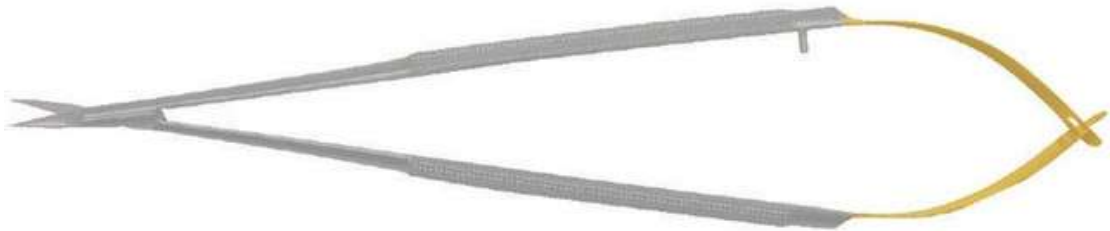

SIZE	6"
S.S	
T.C	
TITANIUM	

SIZE  
6"  
6"  
6"

SIZE	7"
S.S	
T.C	
TITANIUM	

SIZE  
7"  
7"  
7"

SIZE	8"
S.S	
T.C	
TITANIUM	

SIZE  
8"  
8"  
8"

## DENNIS MICRO SCISSORS SPRING ROUND HANDLE DOUBLE ACTION 18.4CM



STRAIGHT	CURVED
S.S	

# Micro Forceps

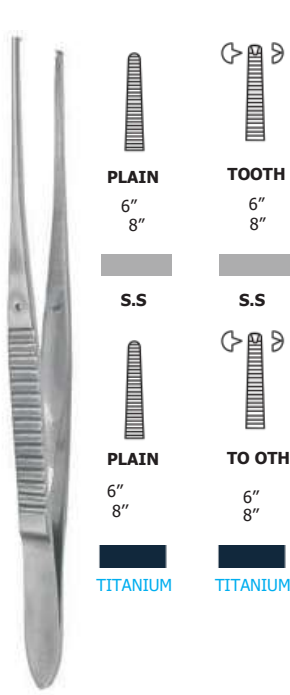

**DISSECTION FORCEPS**  
FINE

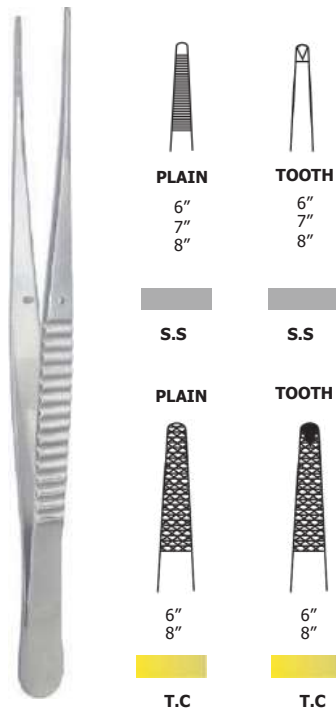

**DISSECTING FORCEPS**

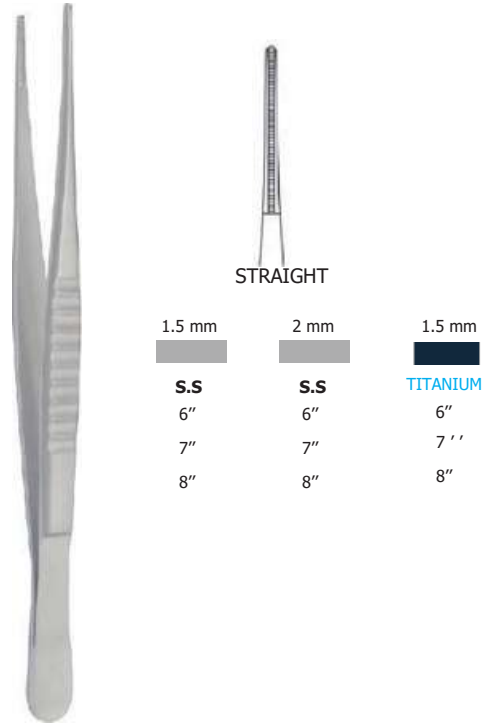

**DEBAKEY VASCULAR FORCEPS**

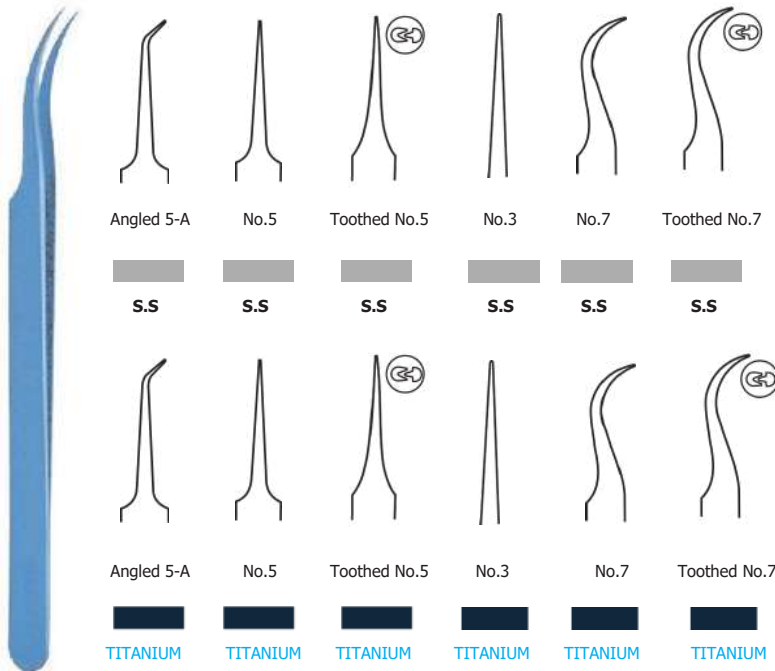

**MICRO JEWELLER FORCEPS**

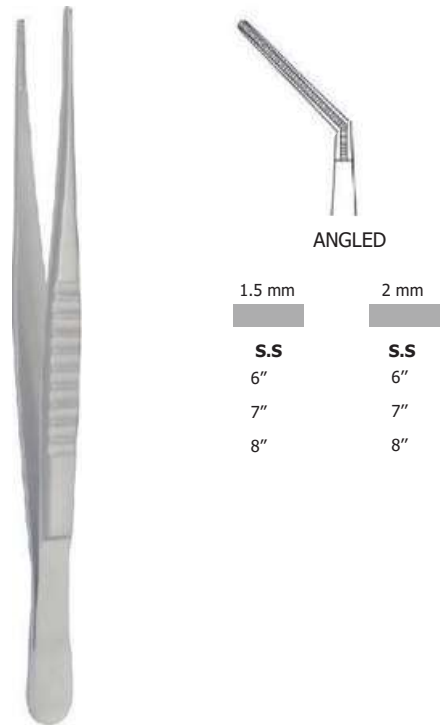

**DEBAKEY VASCULAR FORCEPS**

# Micro Forceps

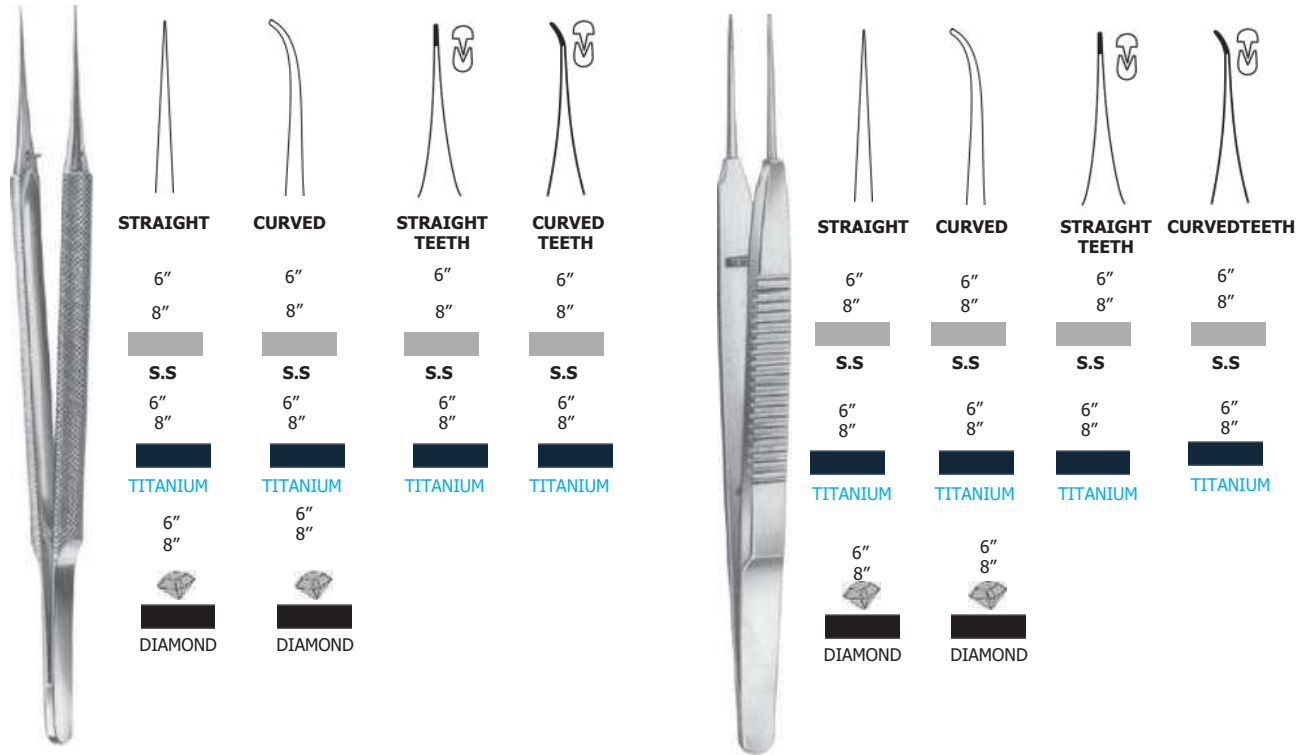

Micro Forceps Round Handle

Plain Micro Forceps Flat Handle

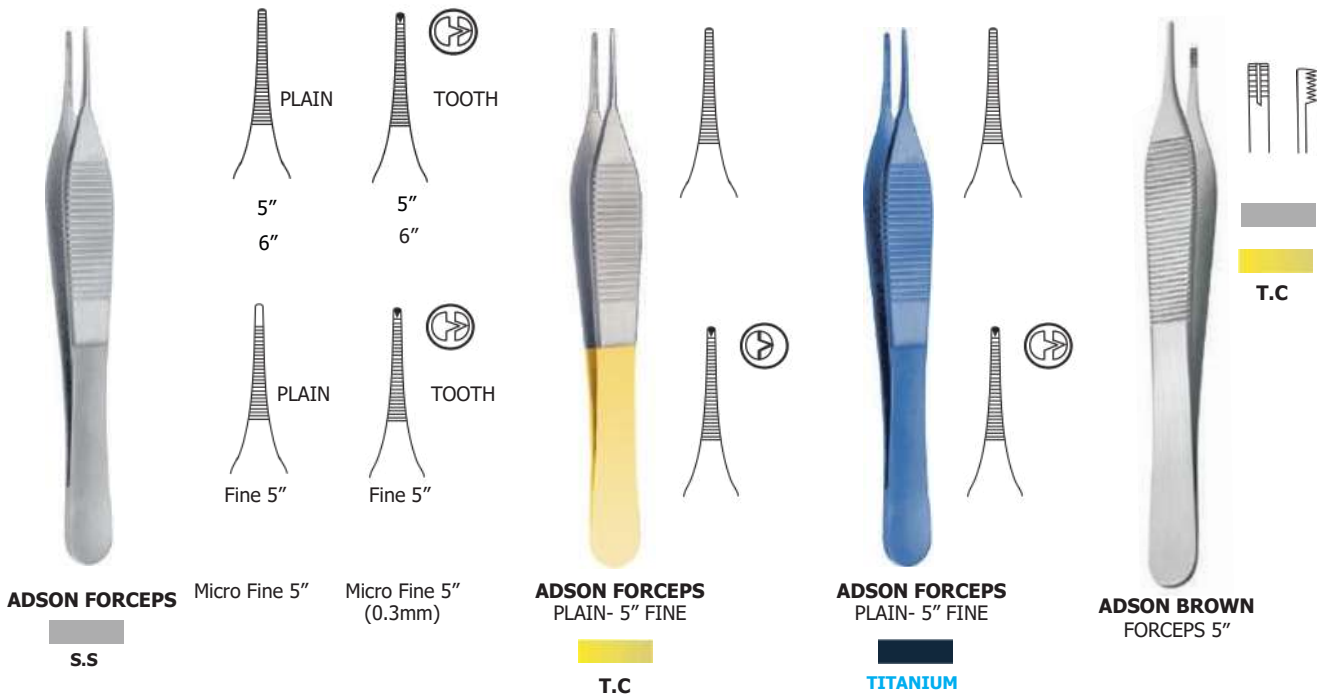

ADSON FORCEPS

Micro Fine 5"

Micro Fine 5" (0.3mm)

ADSON FORCEPS PLAIN- 5" FINE

ADSON FORCEPS PLAIN- 5" FINE

ADSON BROWN FORCEPS 5"

S.S.

T.C.

TITANIUM

# Needle Holders

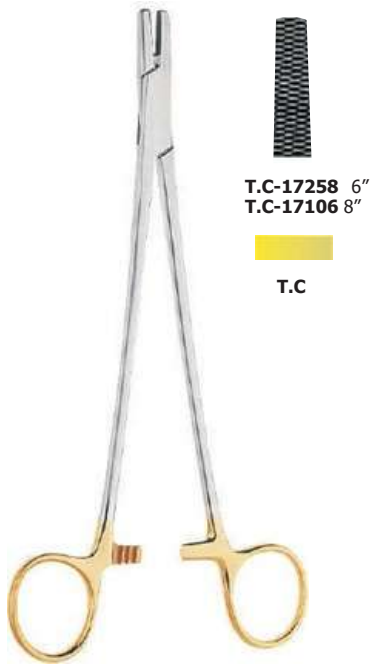

**WIRE TWISTER**

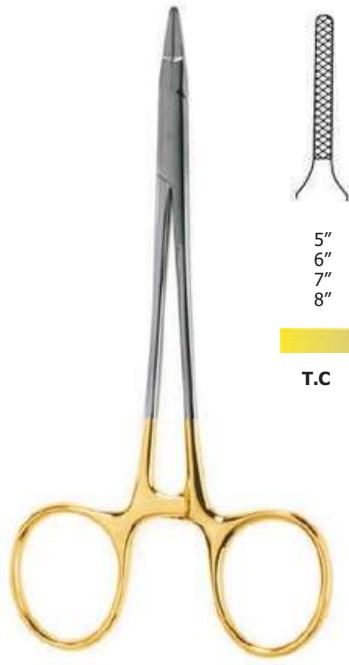

**RYDER NEEDLE HOLDER**

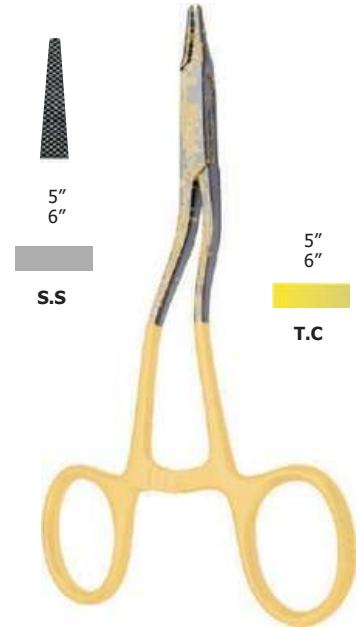

**KILNER NEEDLE HOLDER**

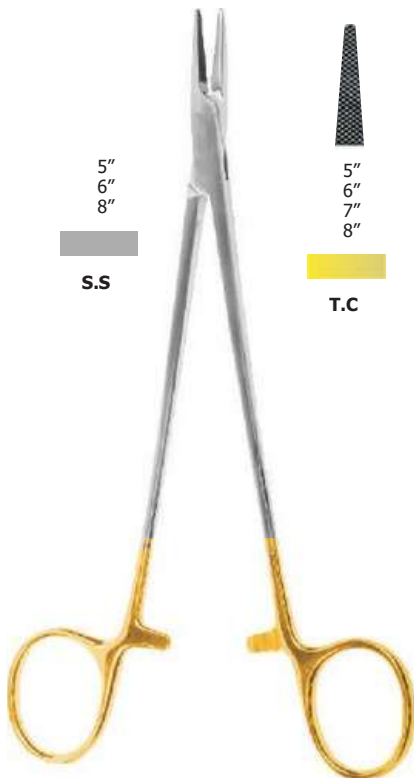

**MICRO VASCULAR NEEDLE HOLDER**



**MICRO VASCULAR NEEDLE HOLDER**

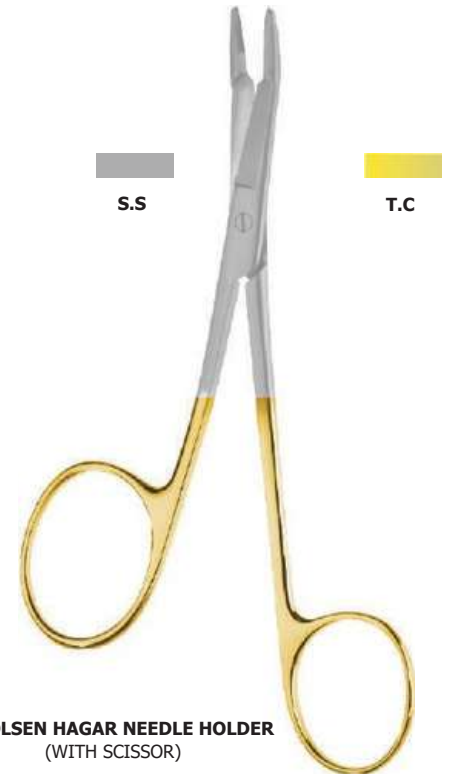

**OLSEN HAGAR NEEDLE HOLDER (WITH SCISSOR)**

# Needle Holders

**MICRO SPRING NEEDLE HOLDER FLAT HANDLE**



**MICRO SPRING NEEDLE HOLDER ROUND HANDLE**

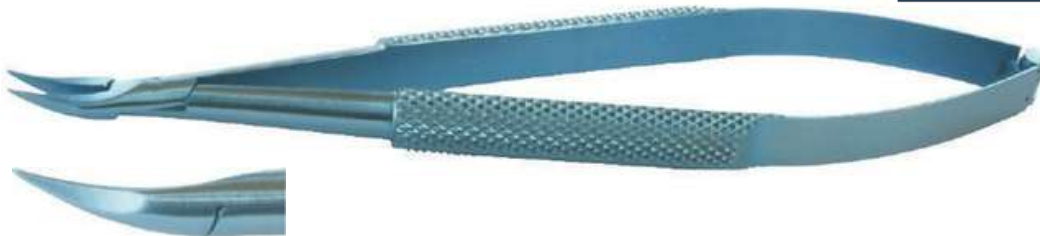

# Bipolar Forceps



16 cm  
19.5 cm  
25 cm

**BIPOLAR COAGULATION**  
FORCEPS BAYONET TYPE



16 cm  
19.5 cm  
**BIPOLAR**

**COAGULATION**  
FORCEPS BAYONET TYPE  
WITH TWO PINS



16 cm  
19.5 cm  
**BIPOLAR**  
**COAGULATION**  
FORCEPS BAYONET TYPE  
WITH SUCTION



16 cm  
19.5 cm  
**BIPOLAR**  
**COAGULATION**  
FORCEPS (ST.)



16 cm  
19.5 cm  
**BIPOLAR**  
**COAGULATION**  
FORCEPS (ST.)  
WITH TWO PINS



16 cm  
19.5 cm  
**BIPOLAR**  
**COAGULATION**  
FORCEPS CURVED



16 cm  
19.5 cm  
**BIPOLAR COAGULATION**  
FORCEPS CURVED  
WITH TWO PINS



16 cm  
19.5 cm  
**BIPOLAR**  
**COAGULATION**  
FORCEPS CURVED



16 cm  
19.5 cm  
**BIPOLAR**  
**COAGULATION**  
FORCEPS CURVED  
WITH SUCTION



16 cm  
19.5 cm  
**BIPOLAR**  
**COAGULATION**  
FORCEPS CURVED  
WITH TWO PINS

# Bipolar Forceps Non-Stick



19.5 cm  
25cm  
**BIPOLAR COAGULATION**  
FORCEPS BAYONET TYPE



19.5 cm  
**BIPOLAR COAGULATION**  
FORCEPS BAYONET TYPE  
WITH TWO PINS



19.5 cm  
**BIPOLAR COAGULATION**  
FORCEPS BAYONET TYPE  
WITH SUCTION



16 cm  
19.5 cm  
**BIPOLAR COAGULATION**  
FORCEPS (ST.)



16 cm  
19.5 cm  
**BIPOLAR COAGULATION**  
FORCEPS (ST.)  
WITH TWO PINS



16 cm  
19.5 cm  
**BIPOLAR COAGULATION**  
FORCEPS CURVE D



16 cm  
19.5 cm  
**BIPOLAR COAGULATION**  
FORCEPS CURVED  
WITH TWO PINS



16 cm  
19.5 cm  
**BIPOLAR COAGULATION**  
FORCEPS CURVED



16 cm  
19.5 cm  
**BIPOLAR COAGULATION**  
FORCEPS CURVED  
WITH SUCTION



16 cm  
19.5 cm  
**BIPOLAR COAGULATION**  
FORCEPS CURVED  
WITH TWO PINS

# Bipolar Forceps



**ADSON FORCEPS**  
11cm, 14cm  
11cm  
14cm



**McPHERSON STRAIGHT  
FORCEPS 8cm**



**McPHERSON CURVED  
FORCEPS 9cm**



**BIPOLAR FORCEPS**  
10cm



**ARTERY FORCEPS  
STRAIGHT**  
7"



**ARTERY FORCEPS  
CURVED**  
7"



**TURNER WARWICK SCISSORS  
STRAIGHT**  
7"



**TURNER WARWICK  
SCISSORS  
CURVED**  
7"



**CABLE**



**MONOPOLAR CABLE**



**BIPOLAR CABLE FLAT PIN**



**BIPOLAR CABLE TWO PIN**

# General Instruments

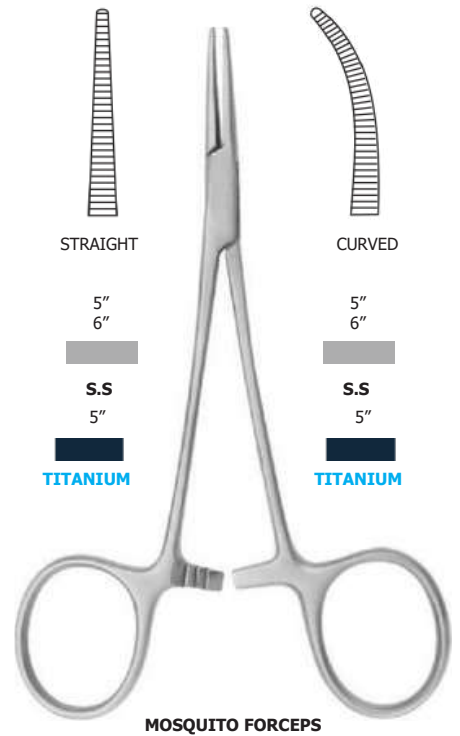
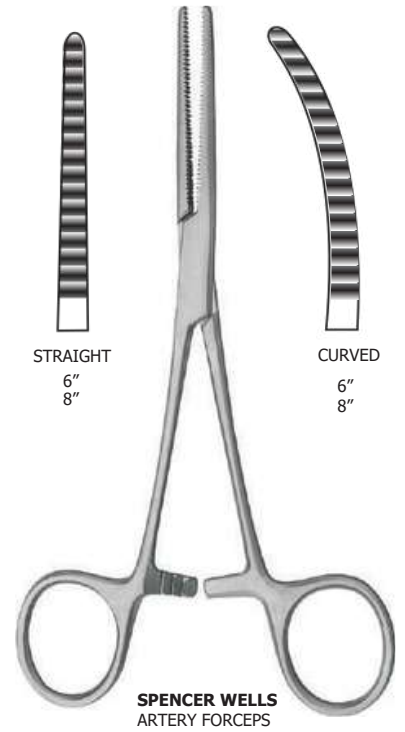
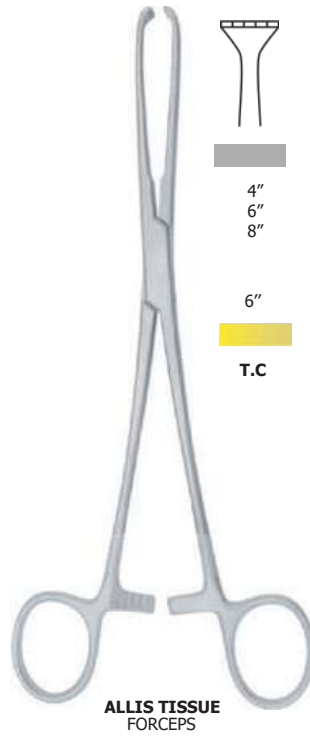
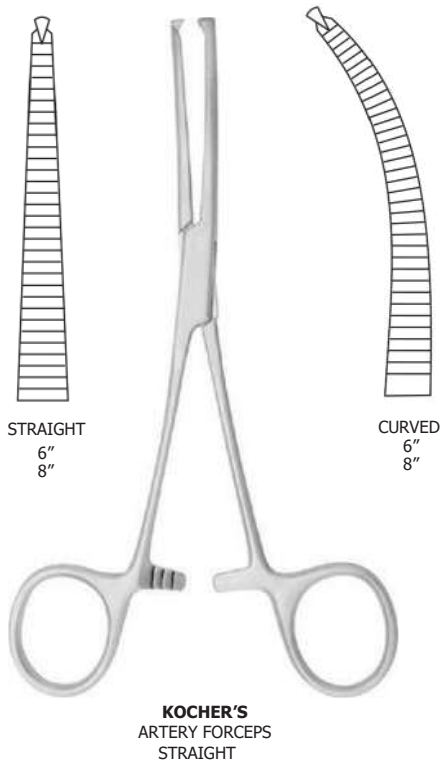

# General Instruments



**BARD PARKER**  
HANDLE No. 3    **BARD PARKER**  
HANDLE No. 4    **BARD PARKER**  
HANDLE No. 7    **B.P. HANDLE**  
ROUND

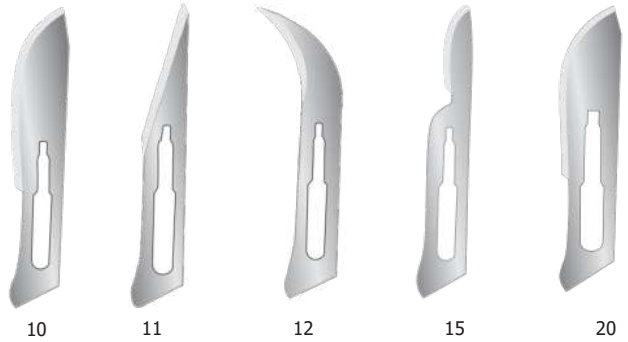

10    11    12    15    20



21    22    23    24

**BARD PARKER BLADES**  
No. 10, 11, 12, 15, 20, 21, 22, 23, 24



**SPONG FORCEPS**  
8"  
10"

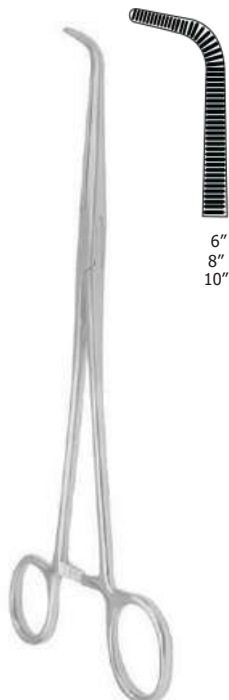

**RIGHT ANGLED FORCEPS**

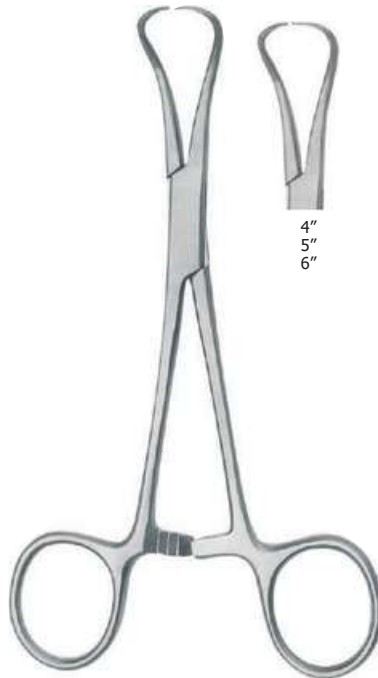

**TOWEL FORCEPS**  
BACKHAUS



**TOWEL CLIP**  
CROSS ACTION

# Holloware Instruments



**MICRO INSTRUMENTS RACK**  
FOR 12 MICRO POINTS



**MICRO INSTRUMENTS TRAY**  
FOR FORCEPS & MICRO POINT  
WITH SILICONE MAT



**AUTOCLAVE INSTRUMENT BOX WITH SILICON MATT**  
20x10x2 CM  
23x20x2 CM  
34x20x2 CM

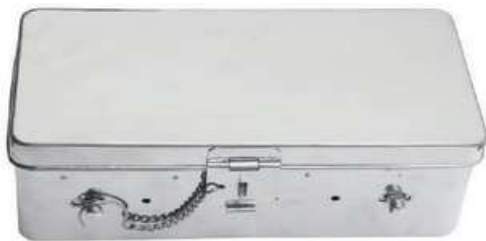

**INSTRUMENT BOX**  
SIZE 20x10x6CM



**KIDNEY TRAY**  
8"  
10"



**DRESSING DRUMS**  
SEAMLESS STAINLESS STEEL  
6" x 6"  
9" x 9"  
9" x 11"



**BOWL**  
STAINLESS STEEL  
3"  
4"  
5"  
6"  
8"



**SURGICAL TRAY WITH LID**  
HEAVY STAINLESS STEEL  
6" x 9"  
7" x 11"  
8" x 10"  
10" x 12"  
12" x 15"



**MEASURING BOWL**



**PORTABLE SINGLE DRUM**  
AUTOCLAVE STAINLESS STEEL  
HEAVY DUTY 12" X 12"

## OPERATING MICROSCOPE

### Technical Specifications:-

- Innovative design, highly versatile with three Step 90 deg. Inclined Optical system on Floor Stand with Cold light
- Co-axial illumination
- Head: Gem Three Step Advance Optical System
- Magnification : 5x, 10x & 20x
- Eye Pieces : SWF 15x paired super wide field
- Working Dist : F=200mm Objective Lens
- Fine Focusing : Manual Fine Focusing
- Light Source : LED Light Source with bright white LED Light
- Arm : Counter balanced pantographic arm with 320° rotation
- Floor Stand: Mobile floor stand on four caster wheels for easy handling and absolute stability
- Power Supply: AC 220V – 240V

### Optional Accessories:

- Beam Splitter with 'C' Mount
- CCD Digital Camera
- LED Screen for Live Surgery
- Motorize with Foot Control
- Objective lens 250mm, 300mm & 400mm
- Monocular assistoscope



## OPERATING MICROSCOP3 LED

- Description : Innovative design, highly versatile with Latest 90 deg. straight Optical system on Floor Stand with Cold light Co-axial illumination
- Head: Five Step Advance Optical System
  - Magnification : 0.4x, 0.6x, 1.0x, 1.6x & 2.5x
  - Eye Pieces : SWF 12.5x paired super wide field
  - Working Dist : F=200mm Objective Lens
  - Fine Focusing : Manual Fine Focusing
  - Illumination : LED Light Source with bright white led light
  - Arm : Counter balanced pantographic arm with 320° rotation
  - Floor Stand: Mobile floor stand on four caster wheels for easy handling and absolute stability
  - Power Supply: AC 220V – 240V (110 volts on request)

# Head Light & Light Source



**BULLS EYE LAMP**  
FOLDING



**FIBER OPTIC**  
HEAD LIGHT  
Band



**LED LIGHT SOURCE**



**LED LIGHTS HEADBAND**  
WITH REACHABLE BATTERY 5 V



**ULTRA COMPACT**  
XENON LIGHT SOURCE 300W



**LOUPS**  
2.5 x  
3.5 x



**FIBER OPTIC CABLE**  
3.5 mm length 230 cm  
4.5 mm length 230 cm



**FIBER OPTIC COLD LIGHT SOURCE**  
SINGLE POINT 15V - 150W



**MURPHY HEAD**  
MIRROR



**FIBER OPTIC COLD LIGHT SOURCE**  
DOUBLE POINT 24 V - 250 W

## ELECTRO SURGICAL CAUTERY UNIT



## EAR PIERCING SYSTEM



### EXCLUSIVE FEATURES

- Advance Embedded Technology based Micro Controller
- Solid State C.M.O.S. integrated circuits.
- Totally Digital Display for every mode.
- Mono-polar cutting/coagulation, blended output.
- Bi-polar cutting/bipolar coagulation
- Independent activation of hand switch and Foot switch
- Audio Visual alarm for separate mode.



**EUROVAC ELECTRIC  
SUCTION MACHINE**



**ENDOSCOPY CAMERA TROLLEY**



**ENDOSCOPY CAMERA  
single chip**



**SILICON TUBE**



**PATIENT CHAIR**  
SPECIFICATION

Power Source	AC 220V/60Hz 500w
Power Consumption	200 x 120/2 Step Arm
Dimension (Head)	630 x 500 340 x 310
Dimension (Back Bone)	400 x 420 ø590 x
Dimension (Elbow Rest)	12.5
Dimension (Seat)	
Dimension (Base)	
Total	650(W)x1700(D)x1200(H)±10%



ATOMISER



**FORMALIN CHAMBERL**

12"
14"
21"
23"
26"



**HYDRAULIC DOCTOR'S STOOL**

**SPECIFICATION**

Revolving Doctor's Stool with Adjustable Back

**FEATURES:**  
**ONE FULLY UPHOLSTERED ELEGANT CHAIR**

WITH FULL MOTORIZED RECLINE FACILITIES  
WITH FULL MOTORIZED UP & DOWN MOVEMENTS  
FOR 300 MM

**ONE STAND AND CONSOLE**

.WITH ILLUMINATING SOFT LIGHT FOR EXAMINATION  
.WITH CONTROLS FOR OPHTHALMIC CHAIR  
.FOR "RECLINE" AND UP & DOWN"  
.FOR "UP & DOWN" MOVEMENT TOOL PEDAL  
IS ALSO PROVIDED AS AN ADDITIONAL OPTION  
.BACK END FORWARD BY MOTORIZED SYSTEM.



## Treatment Units



## Temporal Bone Work Station





# HEALTHCORE VENTURES

build.scale.expand.

Unit no 157, Kaliandas Udyog Bhavan, near Century Bazar, Prabhadevi, Mumbai- 400025

**Tel:** +91 86554 11521

**Email:** [sales@healthcoreventures.com](mailto:sales@healthcoreventures.com)

**Web:** [www.healthcoreventures.com](http://www.healthcoreventures.com)