



HEALTHCORE
VENTURES
build.scale.expand.

PRODUCT CATALOGUE

Cardiac Surgery Instruments

CARDIAC SURGERY INSTRUMENTS

HEMOSTATIC FORCEPS

BRONCHUS CLAMPS

CARDIOVASCULAR CLAMPS

TISSUE FORCEPS

VASCULAR CLAMPS, TITANIUM

RIB & STERNAL SPREADER

RIB SPREADERS

RETRACTORS

ATRIUM RETRACTOR

MICRO FORCEPS

BULLDOG CLAMPS

SCISSORS

NEEDLE HOLDERS

ELEVATORS/DISSECTORS

ENDARTERECTOMY INSTRUMENTS

SUCTION TUBES & CANNULA

PERFUSION CANNULA

LUNG SPATULAS

VESSEL DILATORS & PROBES

BLADES & HANDLES

BIPOLAR FORCEPS

TRAYS & DRUMS

Hemostatic Forceps

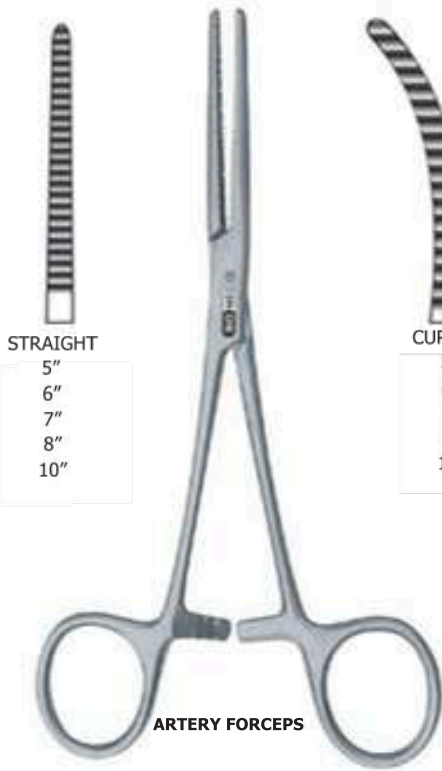

STRAIGHT

5"
6"
7"
8"
10"

ARTERY FORCEPS



CURVED

5"
6"
7"
8"
10"



STRAIGHT

8"
10"

SPONGE
HOLDING FORCEPS



curved
12"

KELLY
POLYPUS FORCEPS



STRAIGHT

4"
5"
6"



CURVED

4"
5"
6"

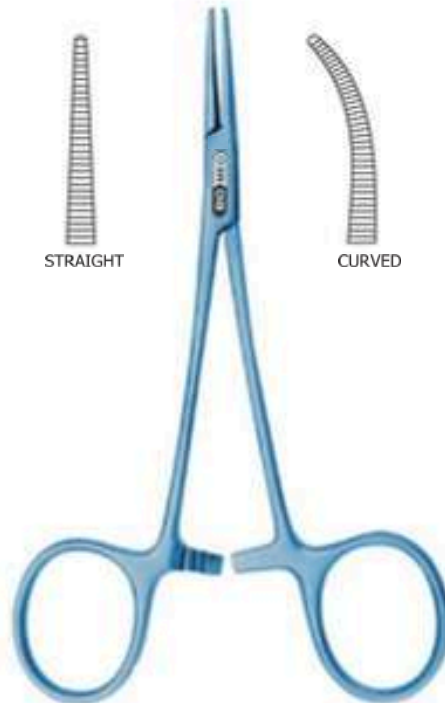

STRAIGHT



CURVED



6"
8"
10"

MIXTURE LIGATURE
RIGHT ANGLED FORCEPS

Hemostatic Forceps

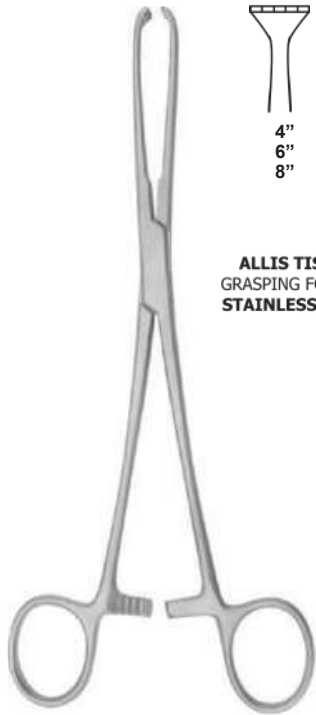

ALLIS TISSUE GRASPING FORCEPS
STAINLESS STEEL



ALLIS TISSUE GRASPING FORCEPS
TUNGSTEN CARBIDE

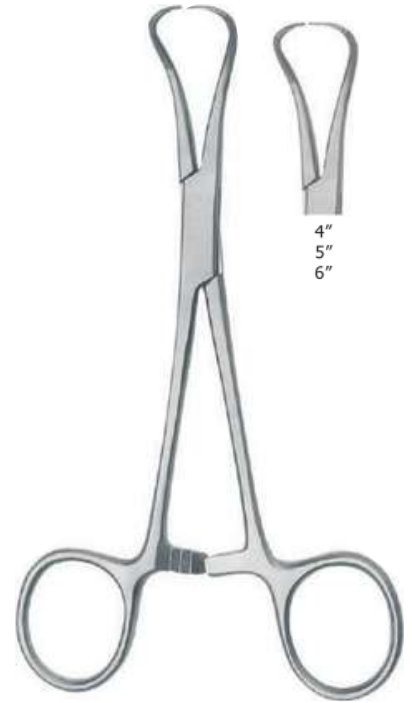

TOWEL FORCEPS
BACKHAUS



CHEATTLE FORCEPS



CHEATTLE JAR



TOWEL CLIP
CROSS ACTION

Hemostatic Forceps

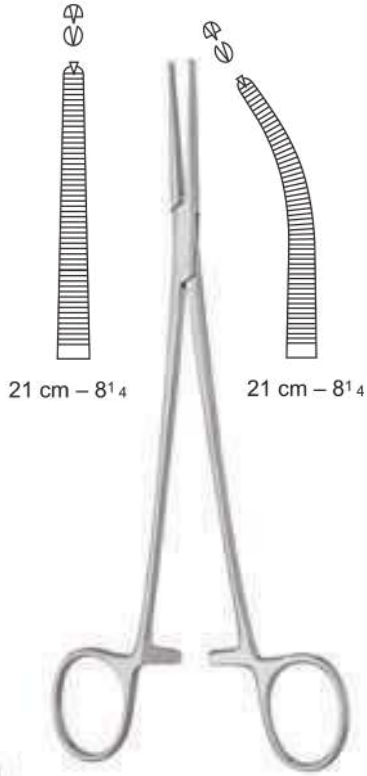

Heiss

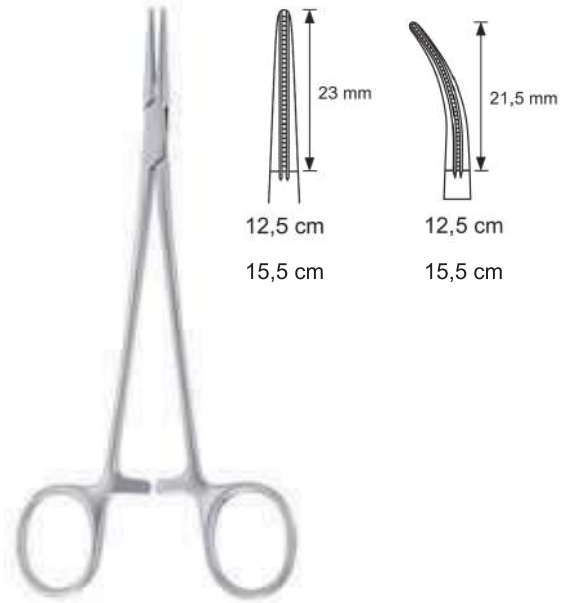

DeBakey "AT"

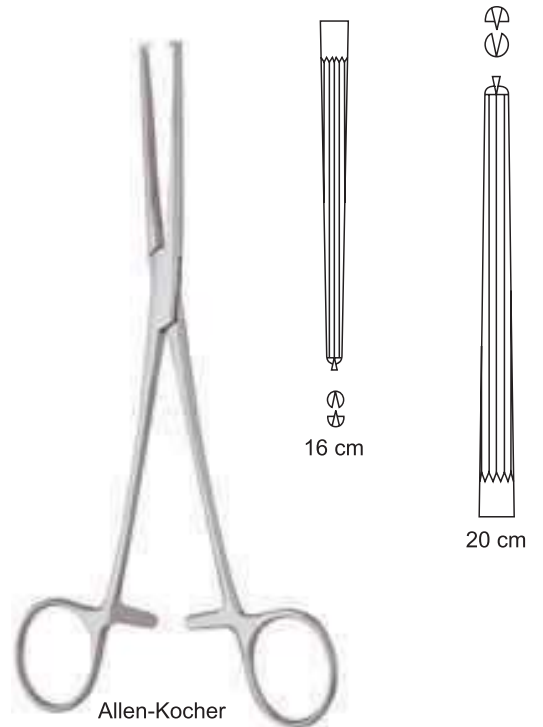
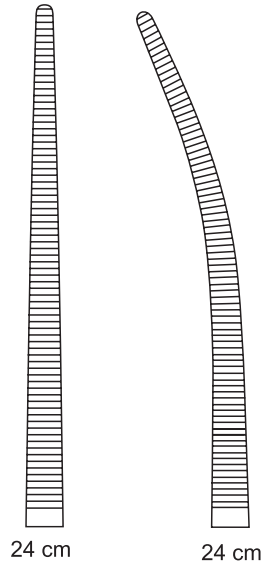

Allen-Kocher

Hemostatic Forceps

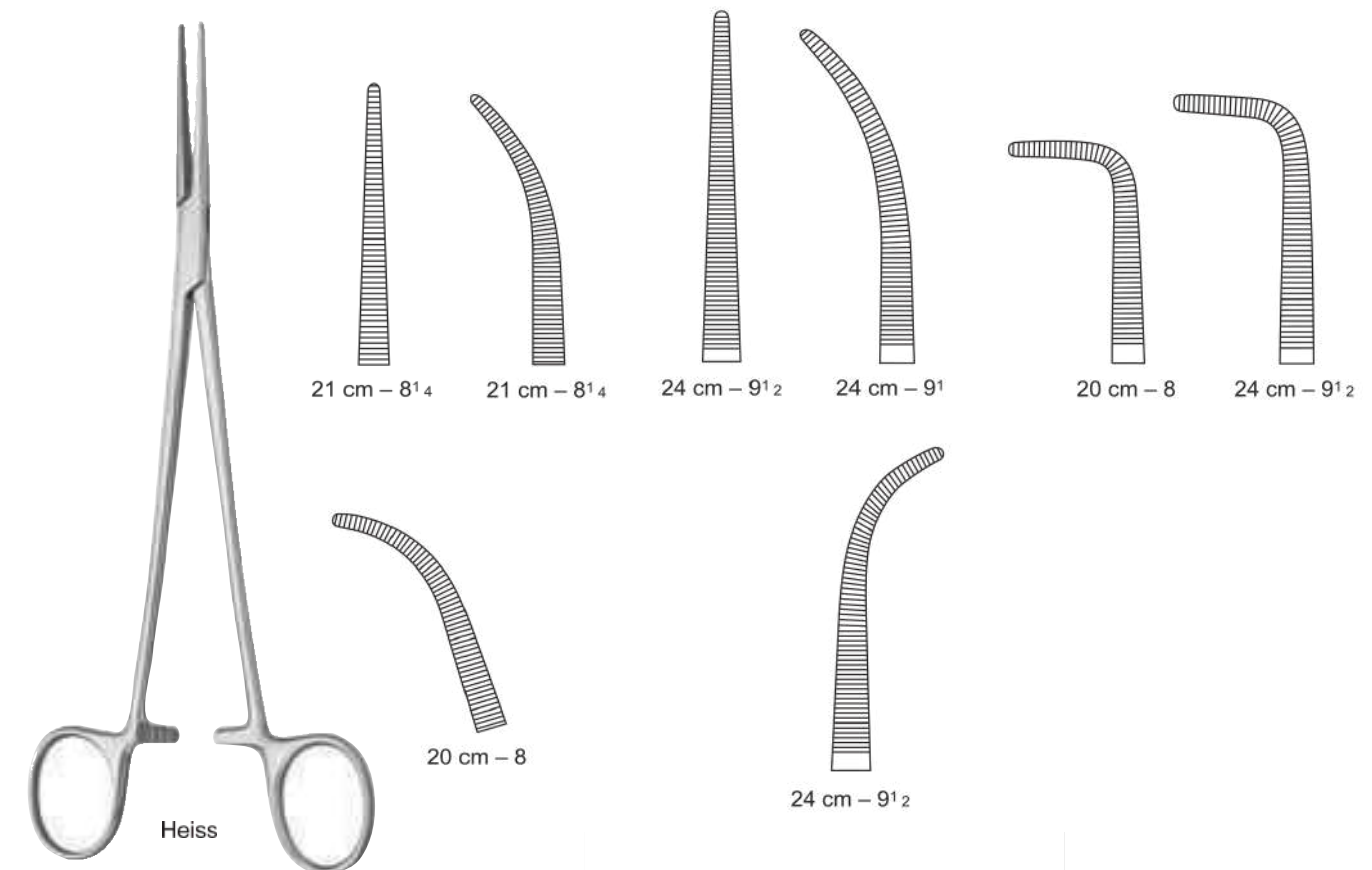
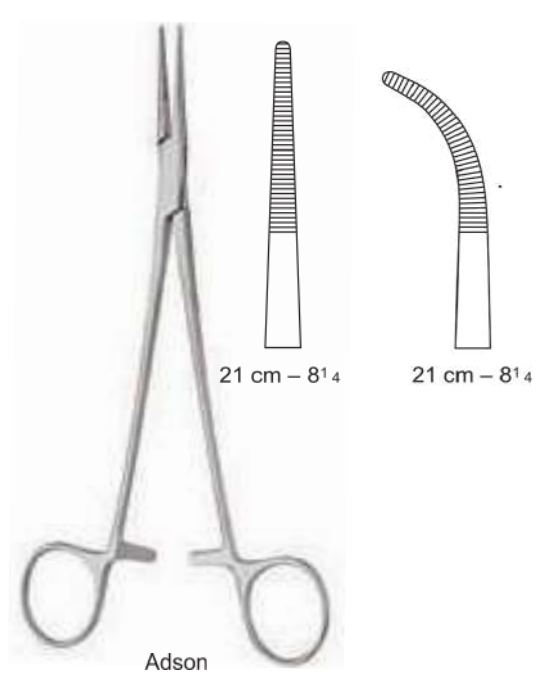
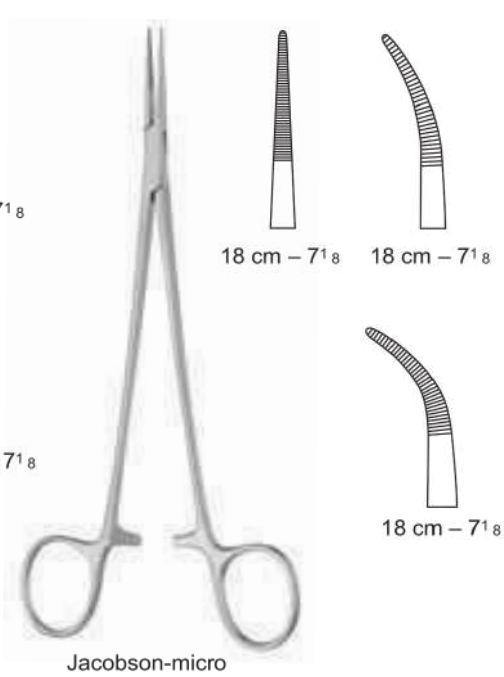
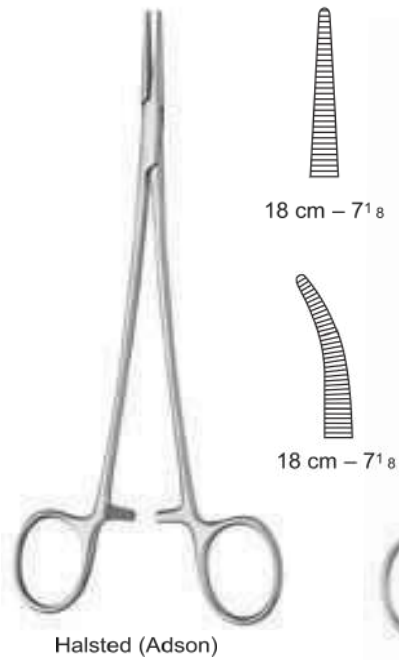

Hemostatic Forceps

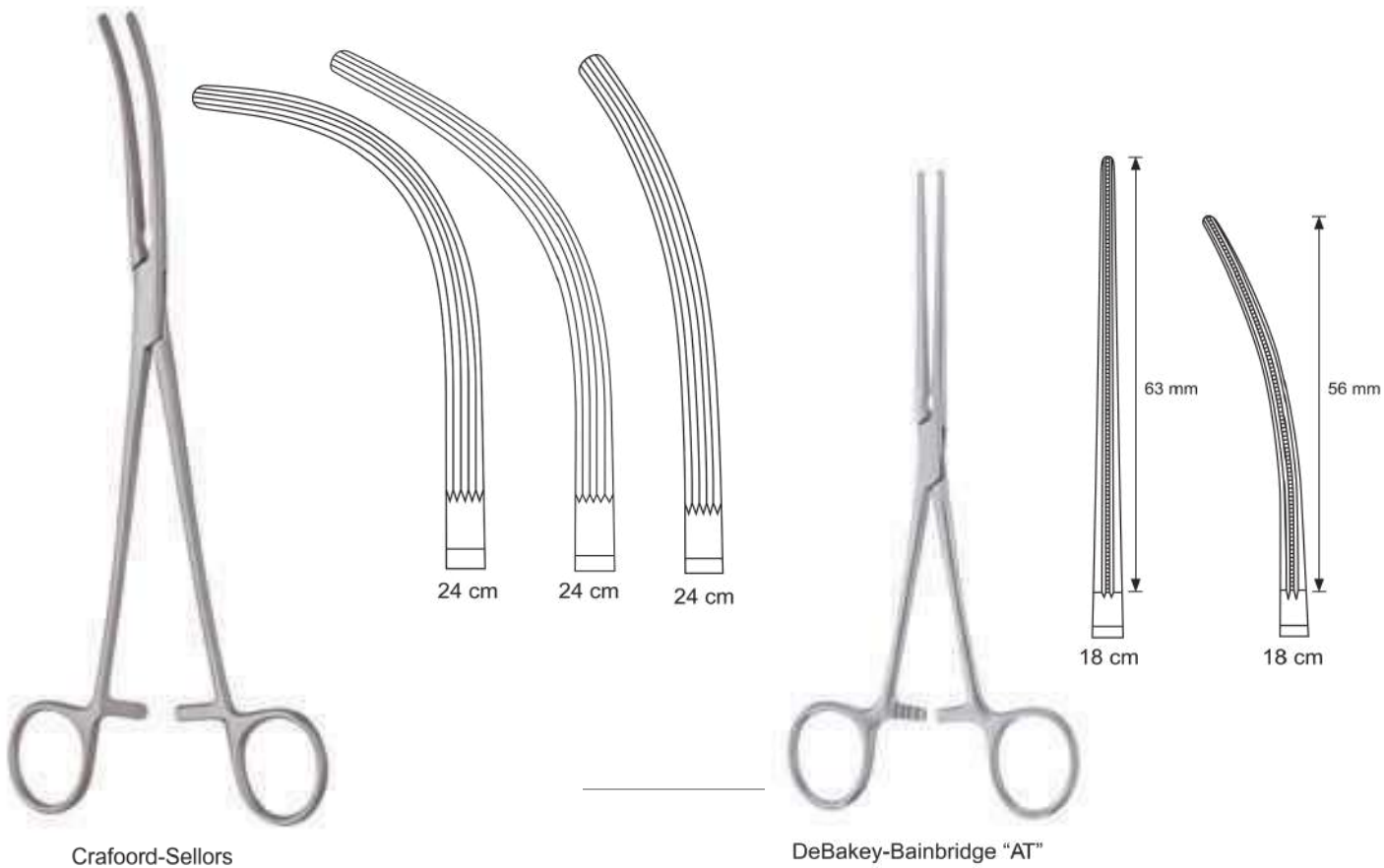
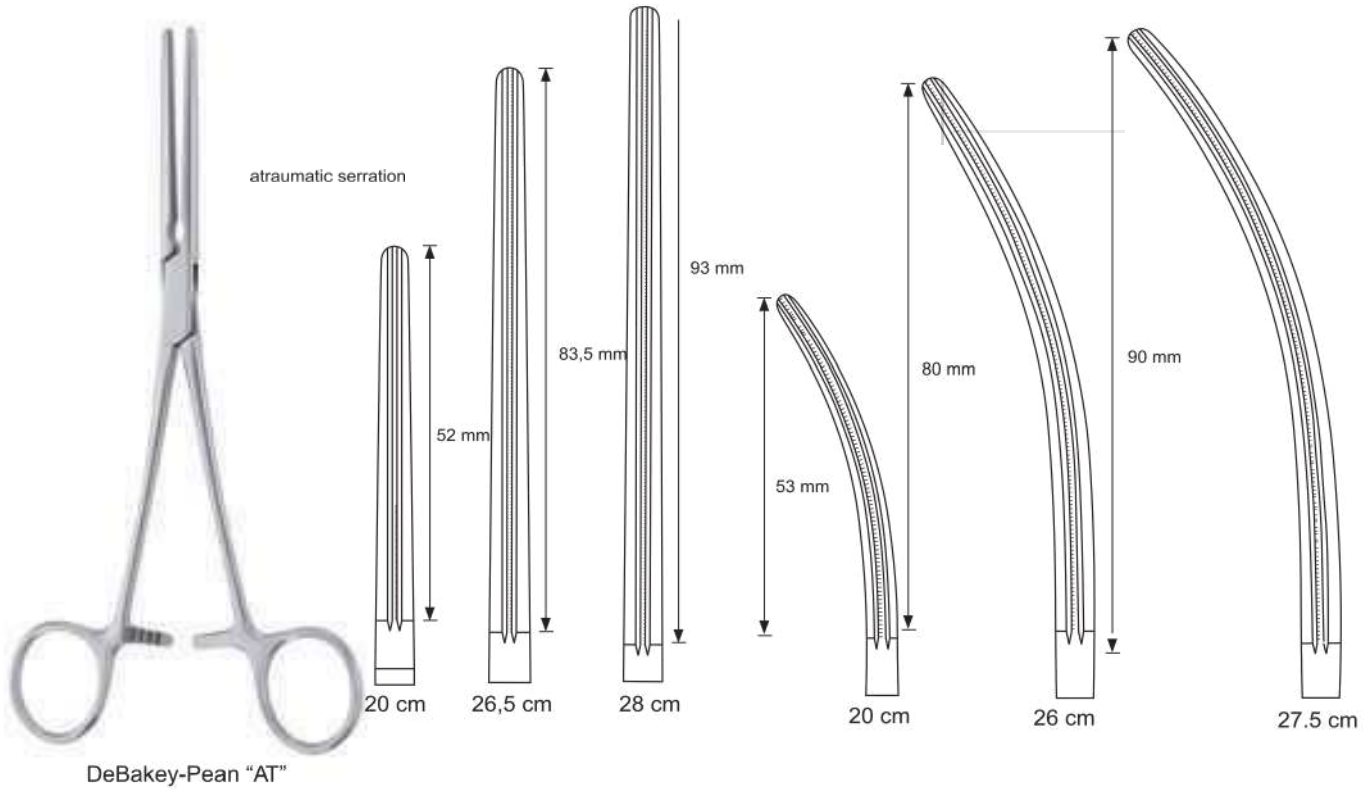

Hemostatic Forceps



Mixer-Craford

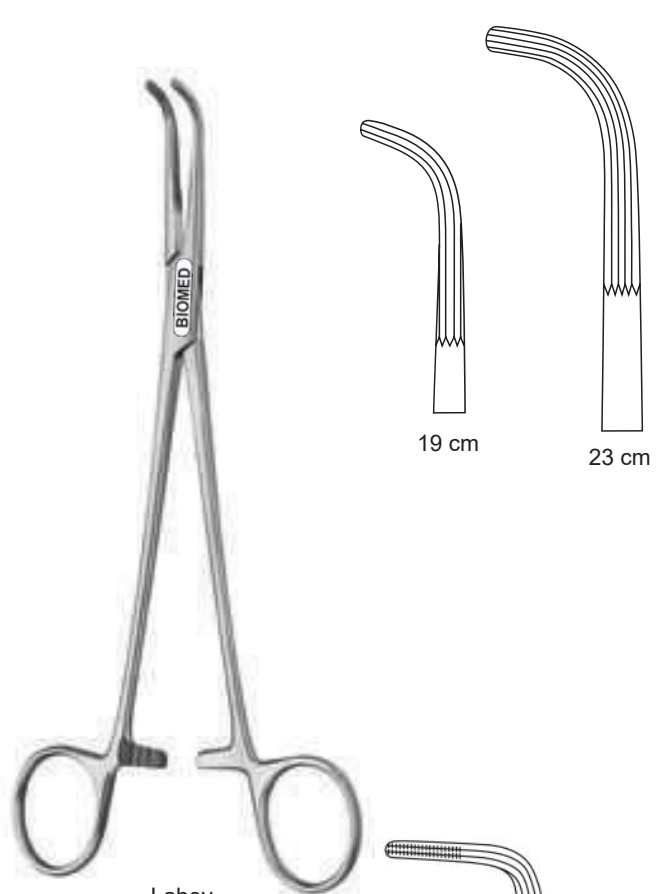

Lahey

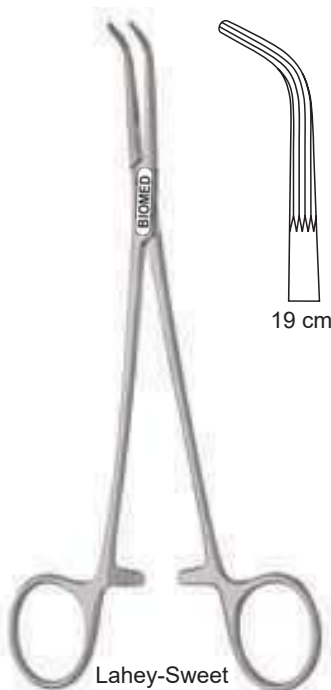

Lahey-Sweet

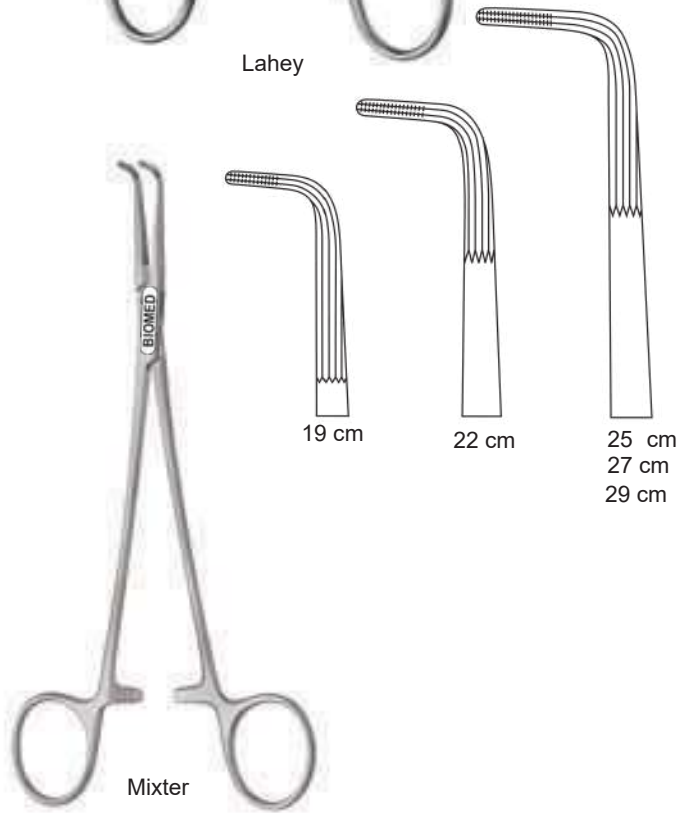

Mixer

Bronchus Clamps

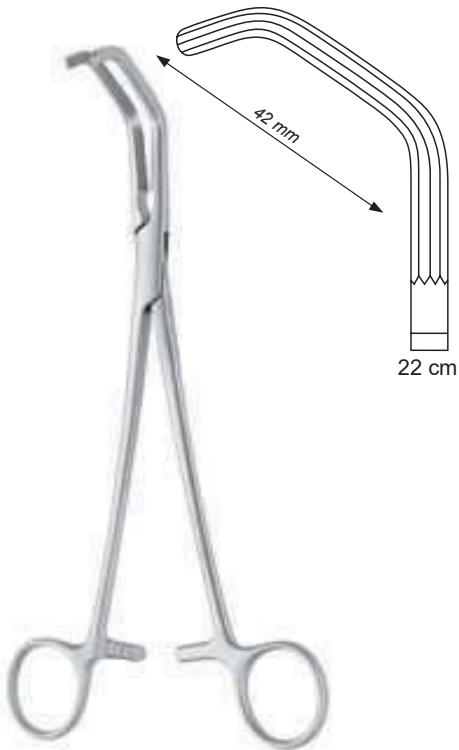

Price-Thomas



Price-Thomas



22 cm
LEFT



23 cm
LEFT



23 cm
RIGHT



Sarot



RIGHT ANGLED



Semb

Bronchus Clamps

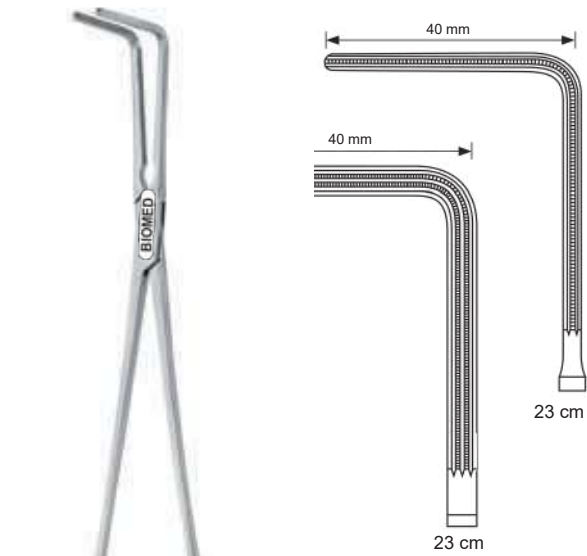

Cardiovascular Clamps

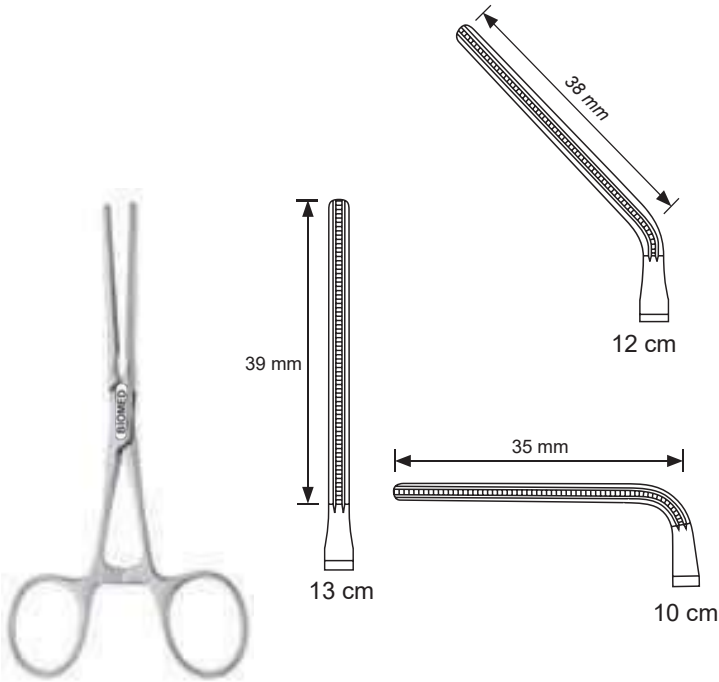

DeBakey "AT"

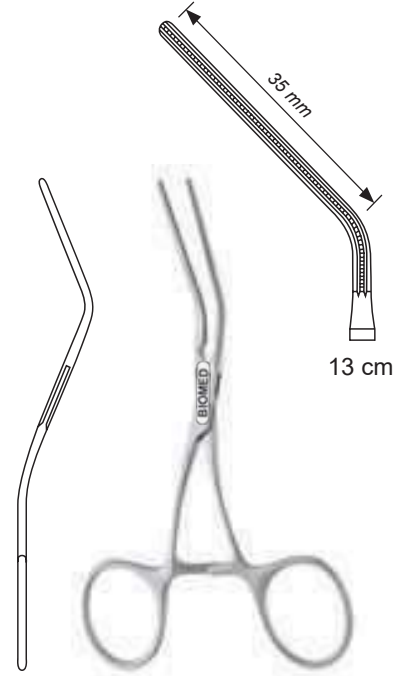

DeBakey "AT"

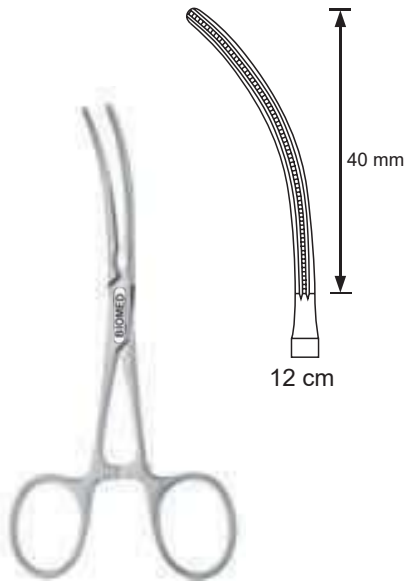

DeBakey "AT"

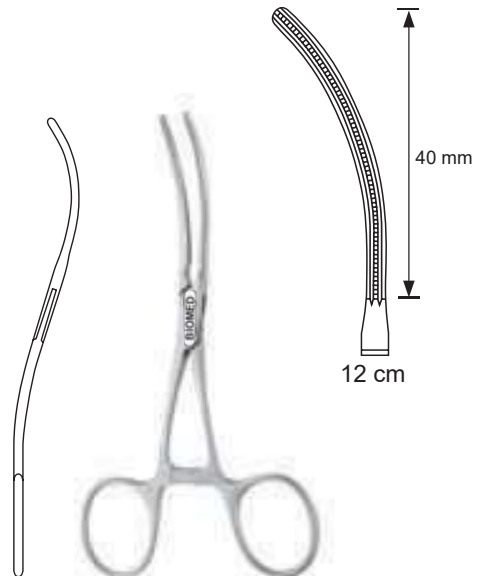

DeBakey "AT"

Cardiovascular Clamps

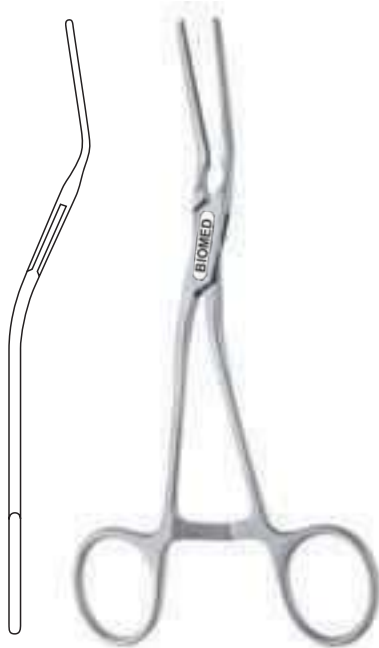

DeBakey "AT"
Multipurpose clamps

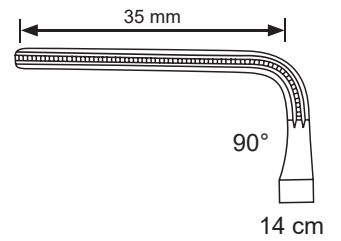
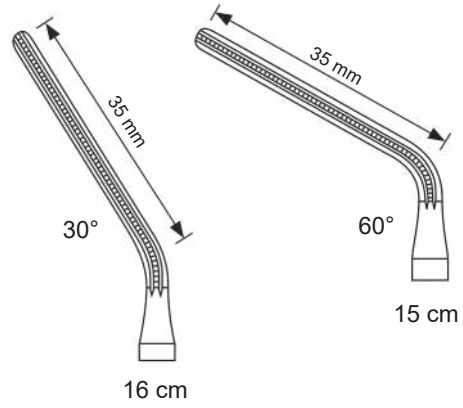

Cooley "AT"

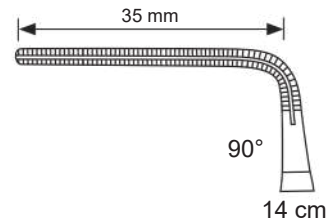
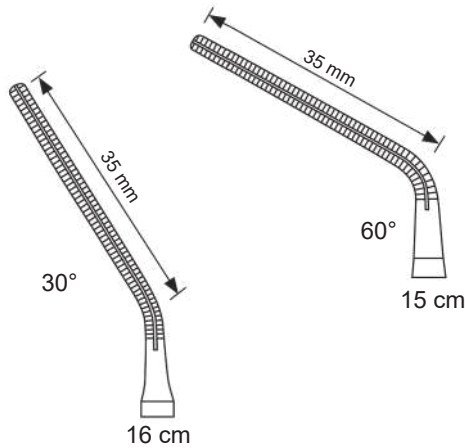

Cardiovascular Clamps

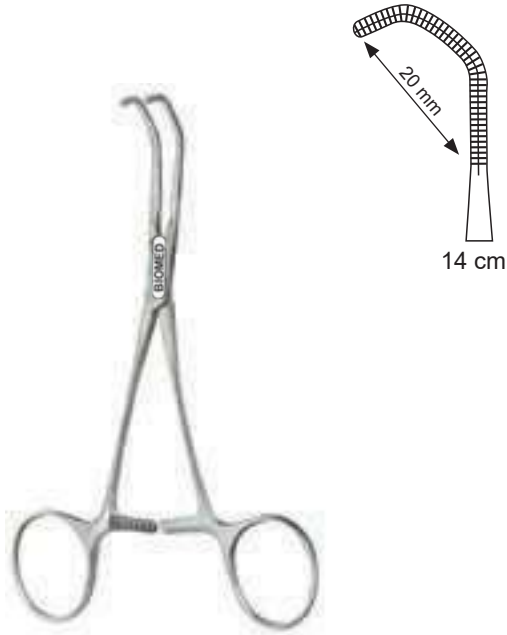

Cooley "AT"

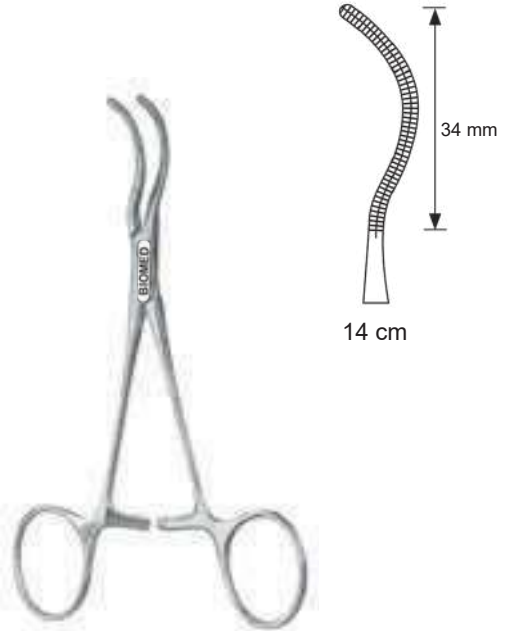

Cooley "AT"



Gregory "AT"

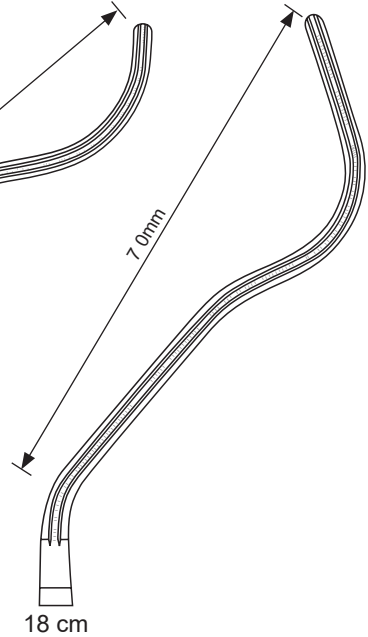
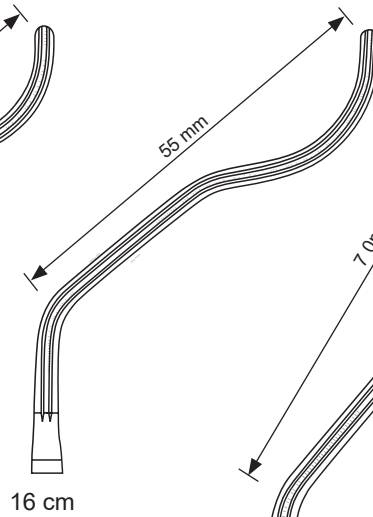
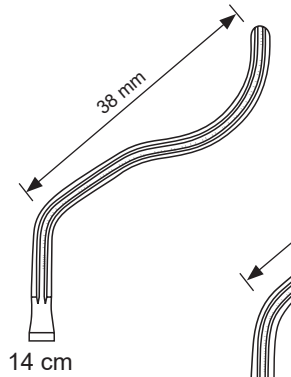

Cardiovascular Clamps

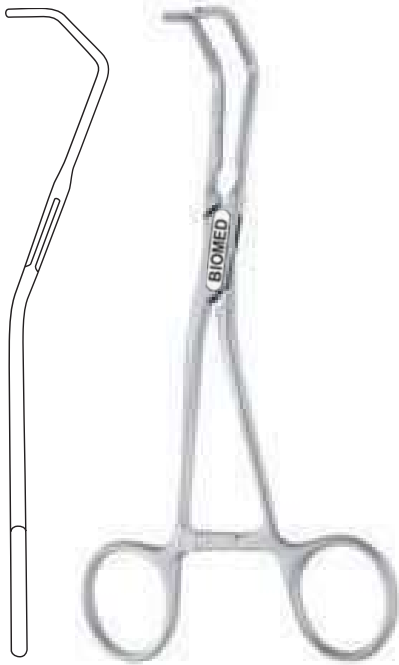

Cooley "AT"
Multipurpose clamps

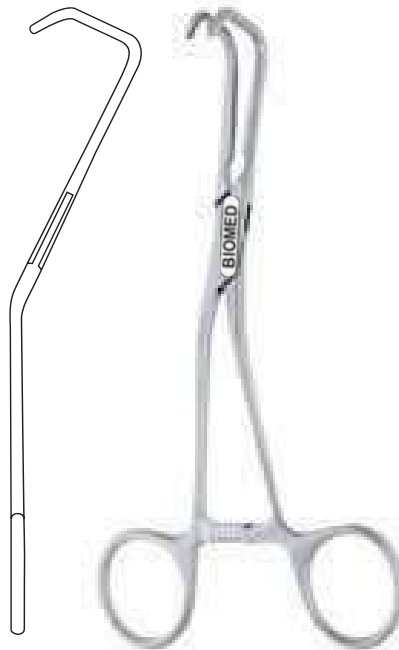
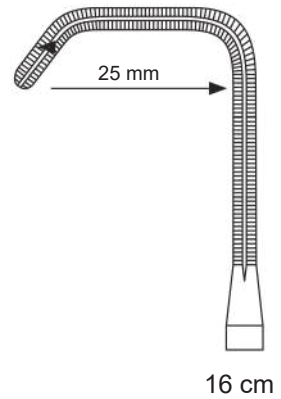
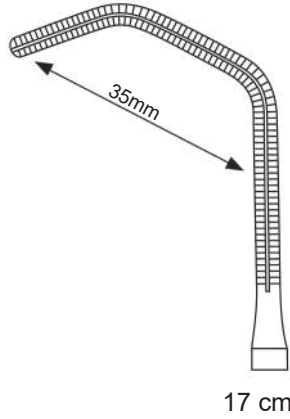

Cooley "AT"
Multipurpose clamps

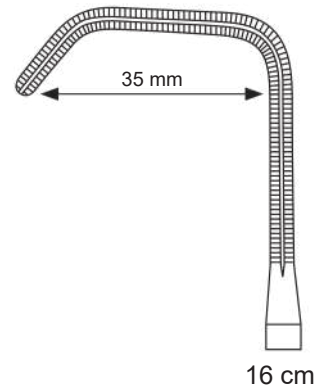

Cardiovascular Clamps

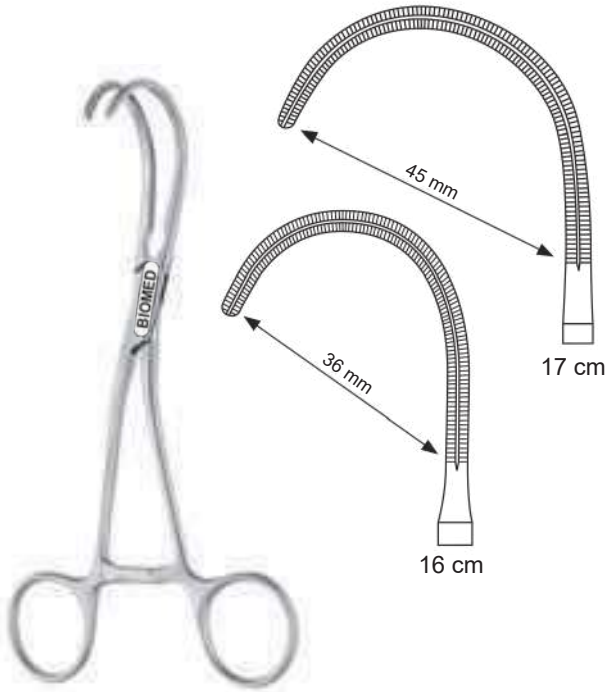

Cooley "AT"

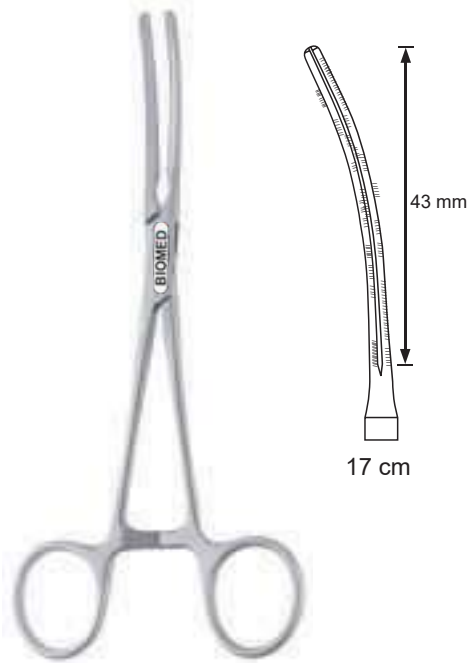

Cooley-Glover "AT"

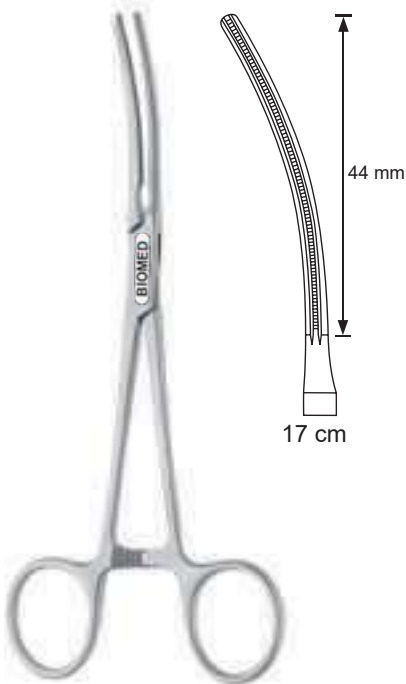

DeBakey-Glover "AT"



Potts-Glover

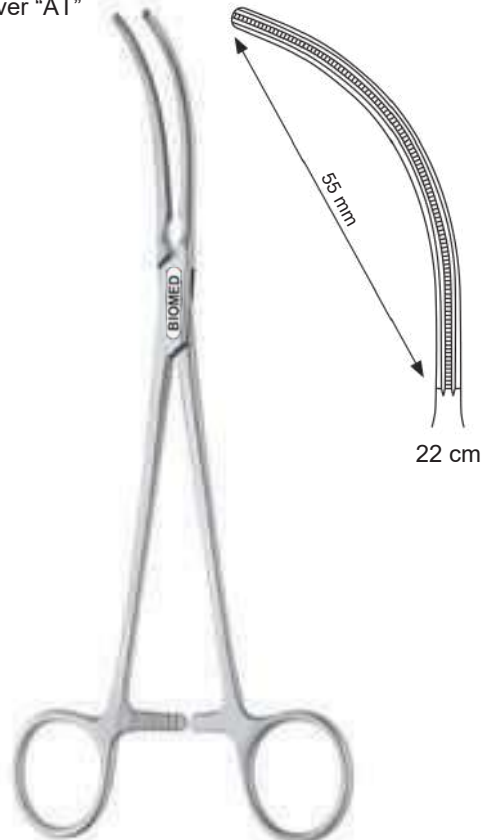

DeBakey-Glover "AT"

Cardiovascular Clamps



Dardik "AT"

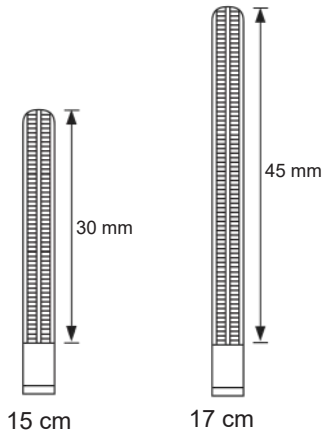

Multipurpose clamps

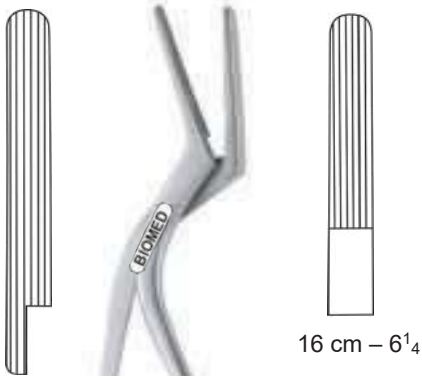
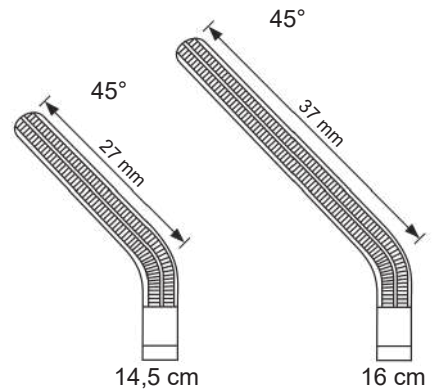
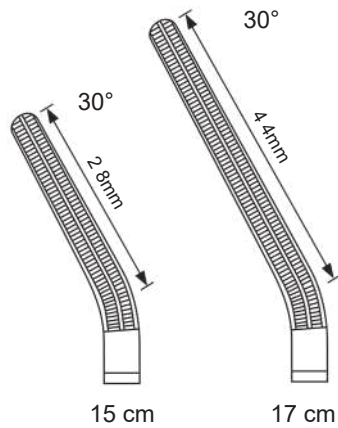
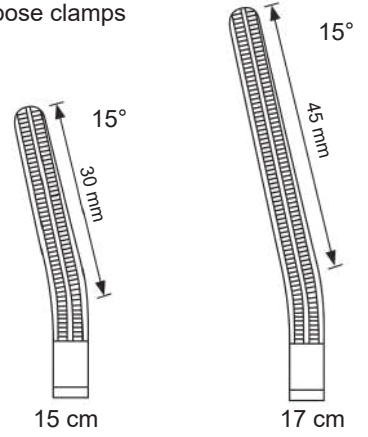

Höpfner

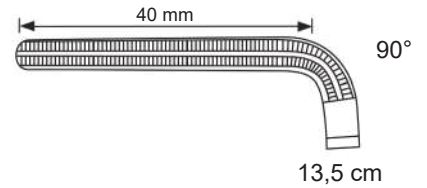
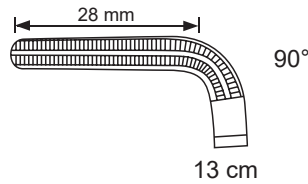

Cardiovascular Clamps

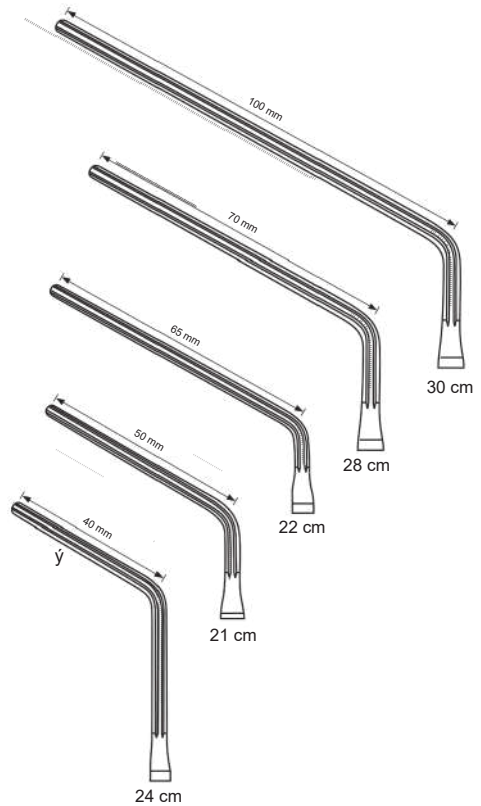
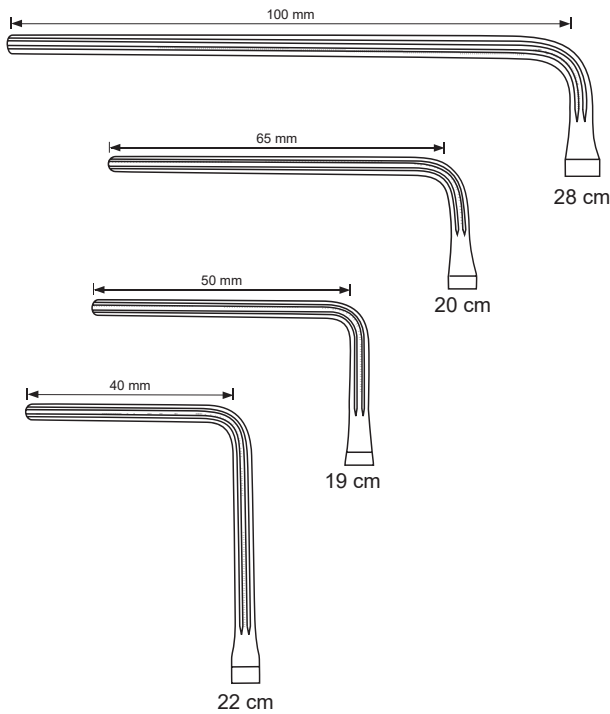

Cardiovascular Clamps

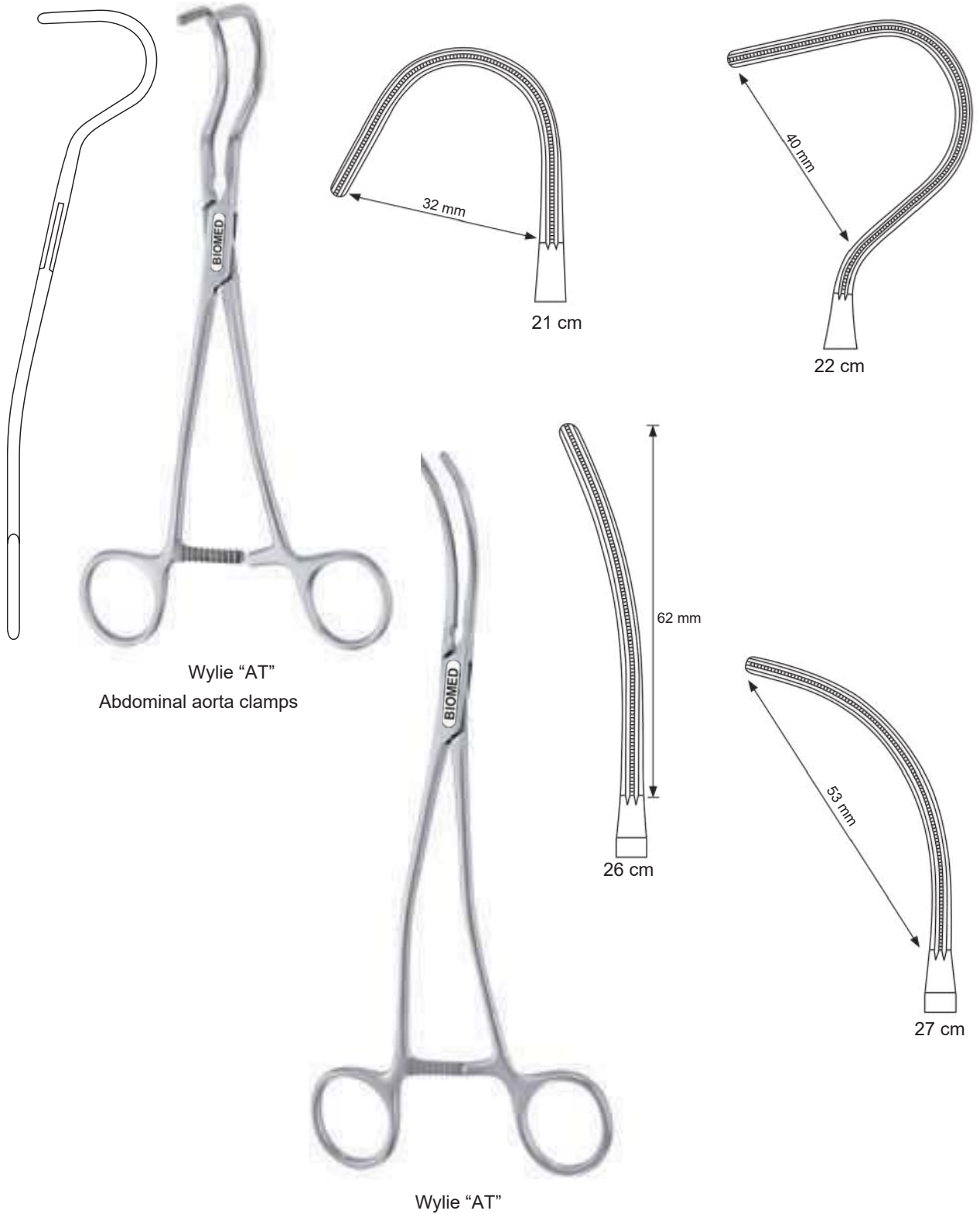

Cardiovascular Clamps

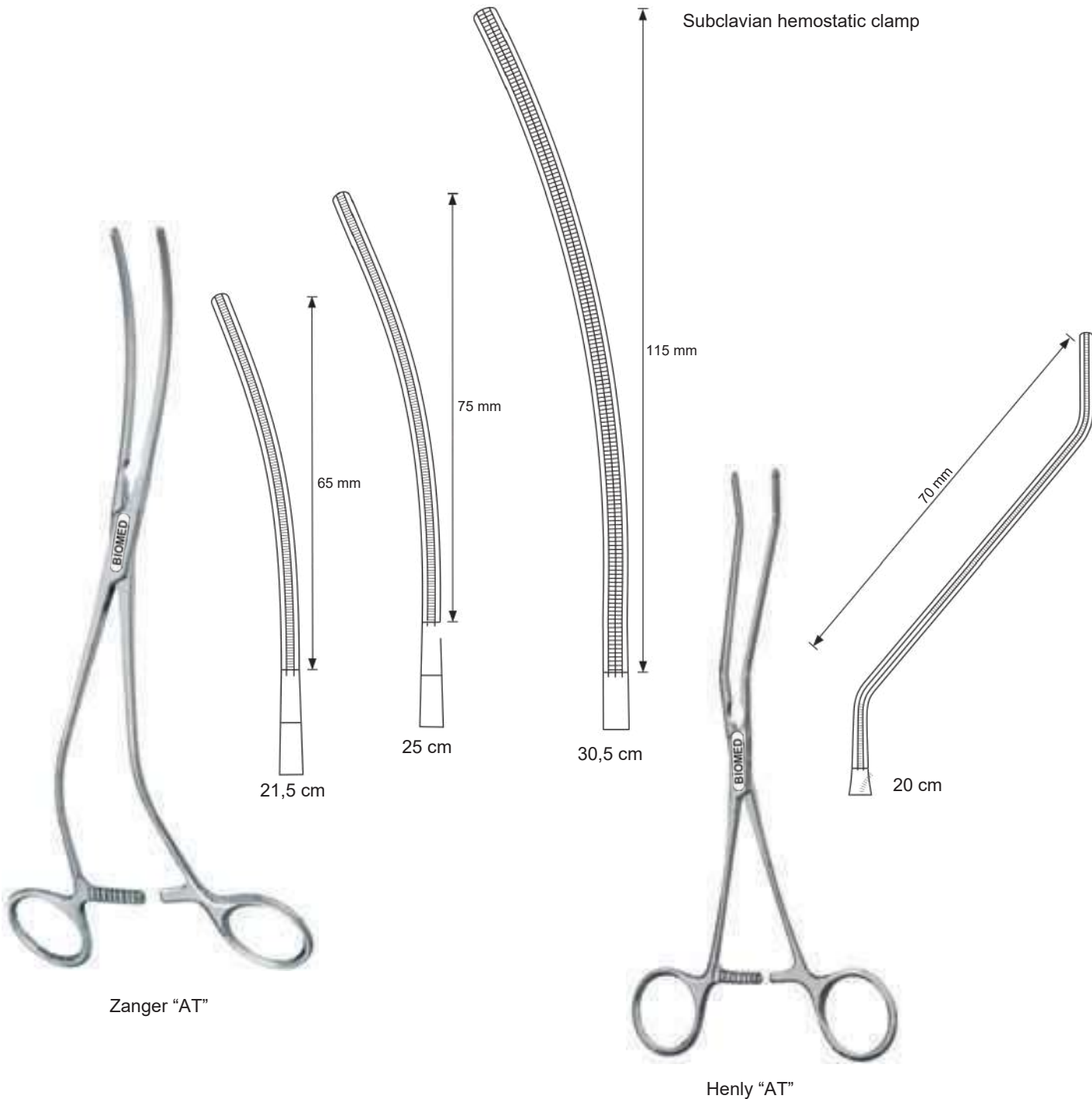

Cardiovascular Clamps



Lemole "AT"

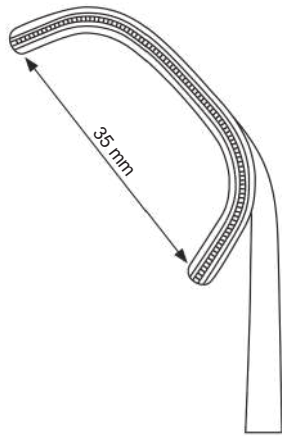

20,5 cm

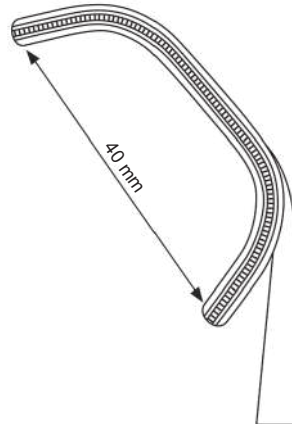

20,5 cm

Aorta clamps

Carotid clamps



DeBakey "AT" Husfeldt

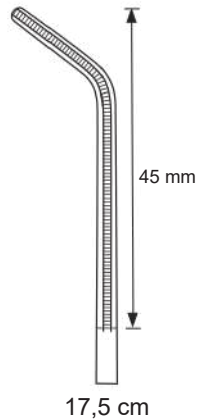

17,5 cm

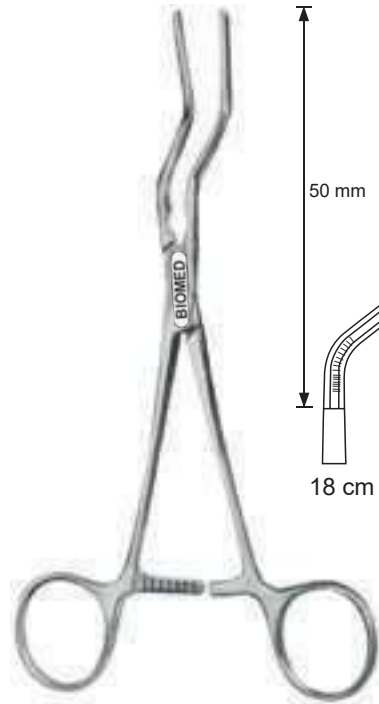

DeBakey "AT" Husfeldt

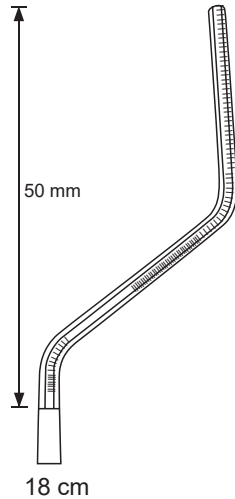

18 cm

Cardiovascular Clamps



DeBakey "AT" Husfeldt

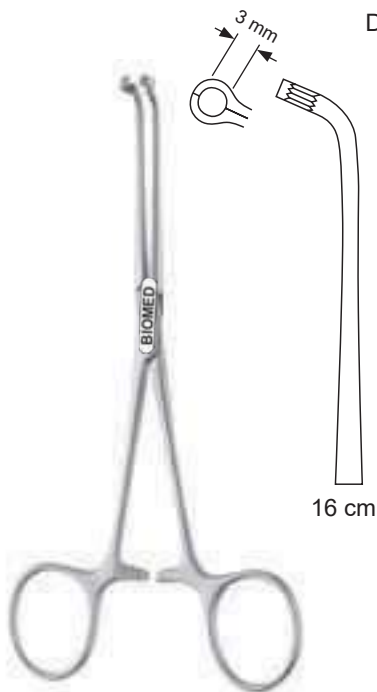

Javid



Javid

Cardiovascular Clamps

Tangential occlusion clamps

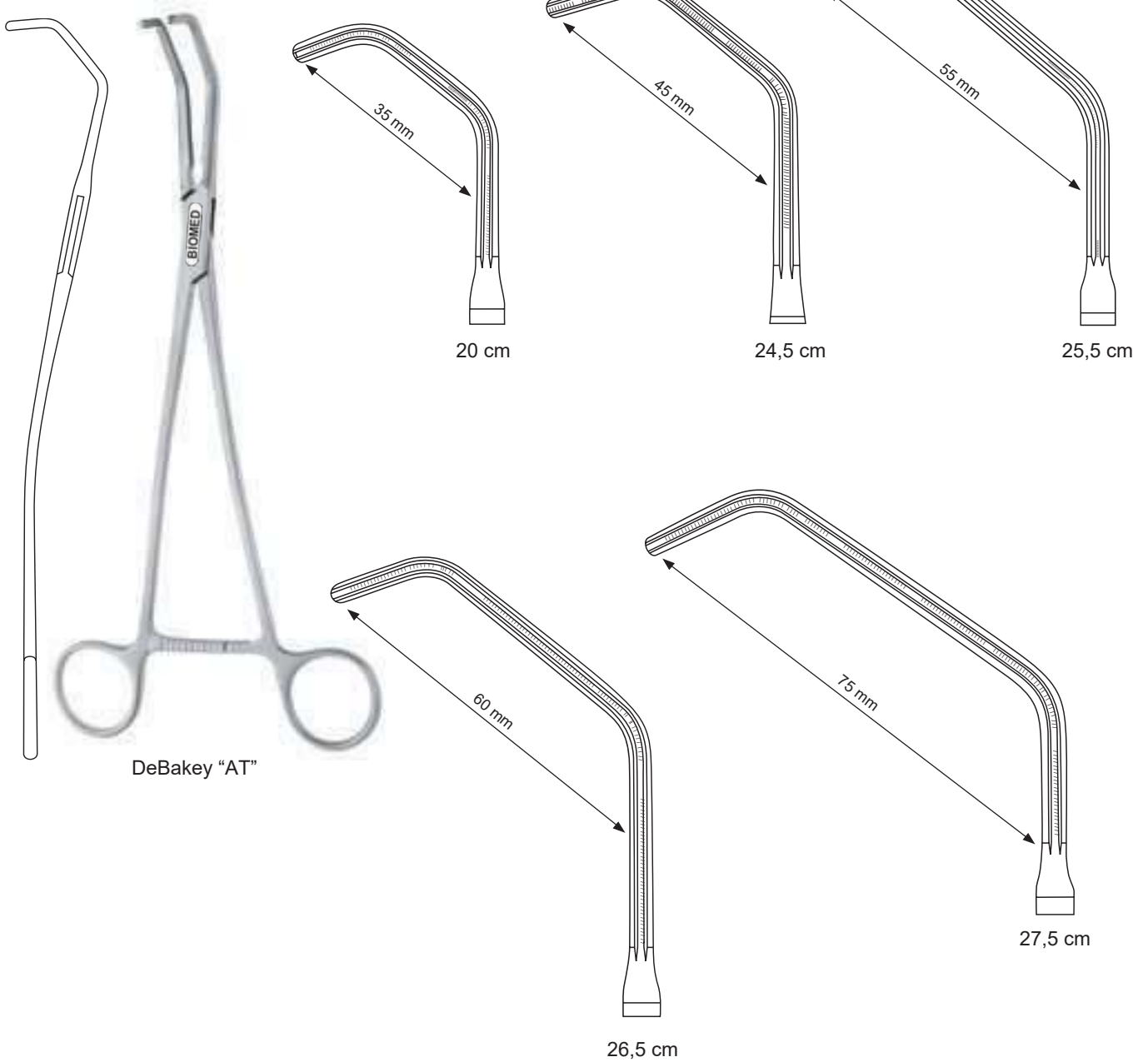

Cardiovascular Clamps

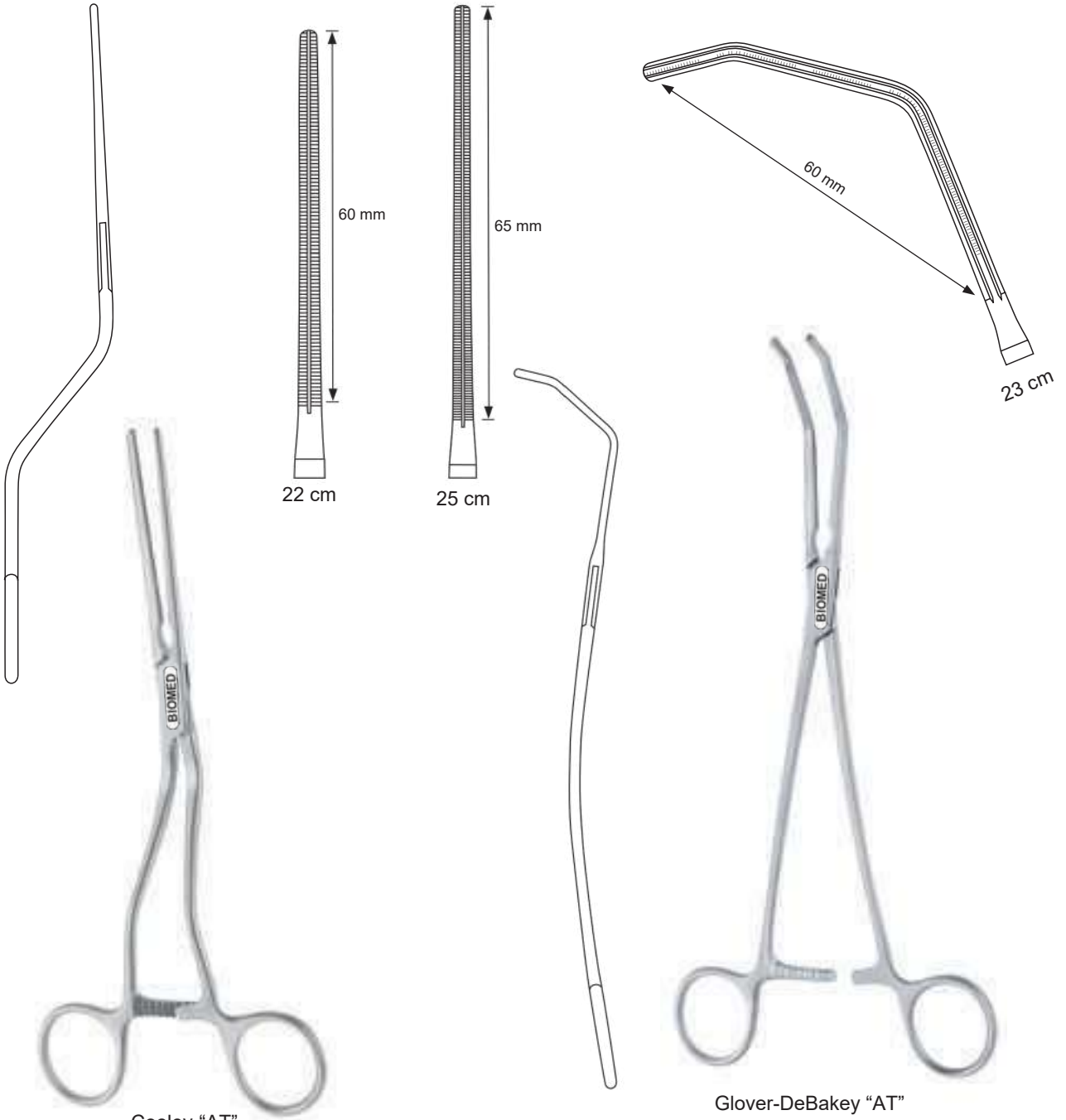

Cooley "AT"
Iliac clamps

Glover-DeBakey "AT"
Auricle clamp

Cardiovascular Clamps



Potts
Patent ductus clamps

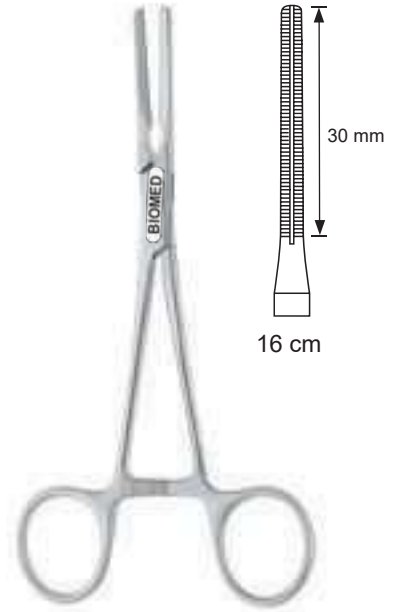

Cooley "AT"



Cooley "AT"

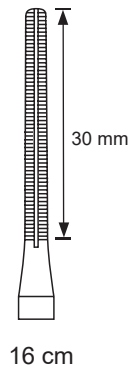

Cardiovascular Clamps

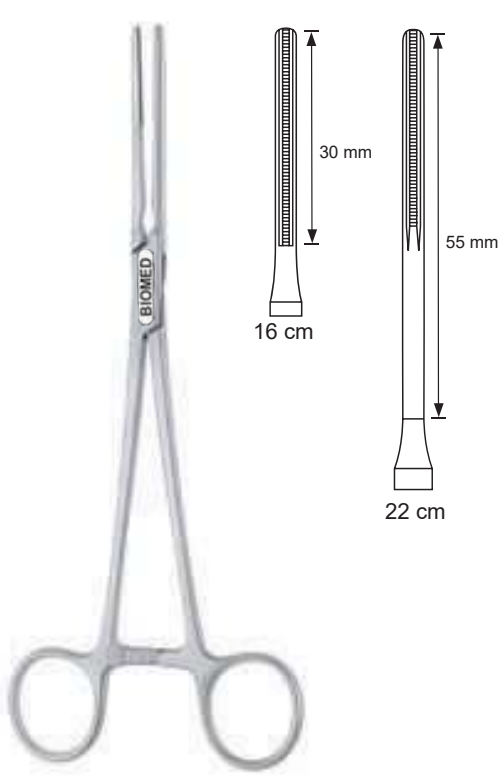

DeBakey "AT"
Patent ductus clamps

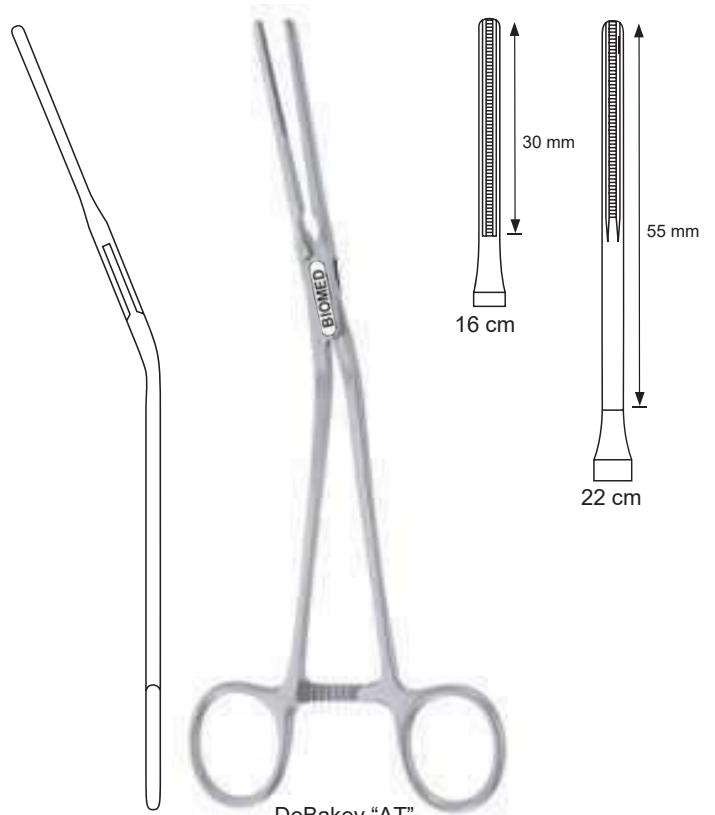

DeBakey "AT"
Patent ductus clamps

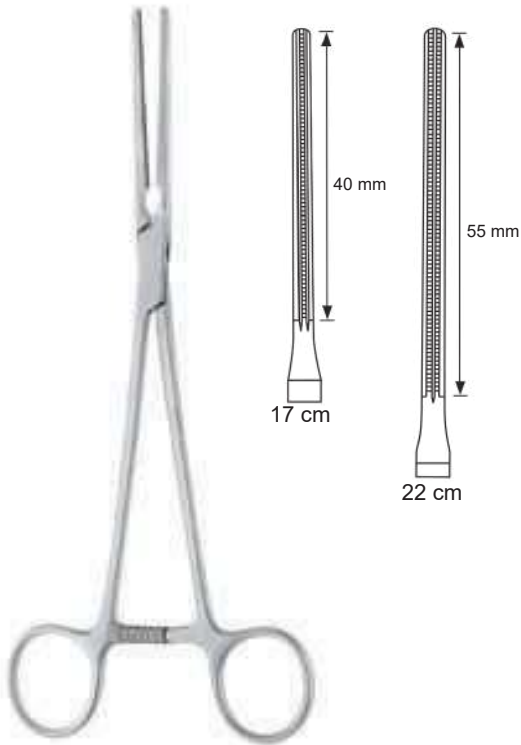

DeBakey "AT"
Coarctation clamps

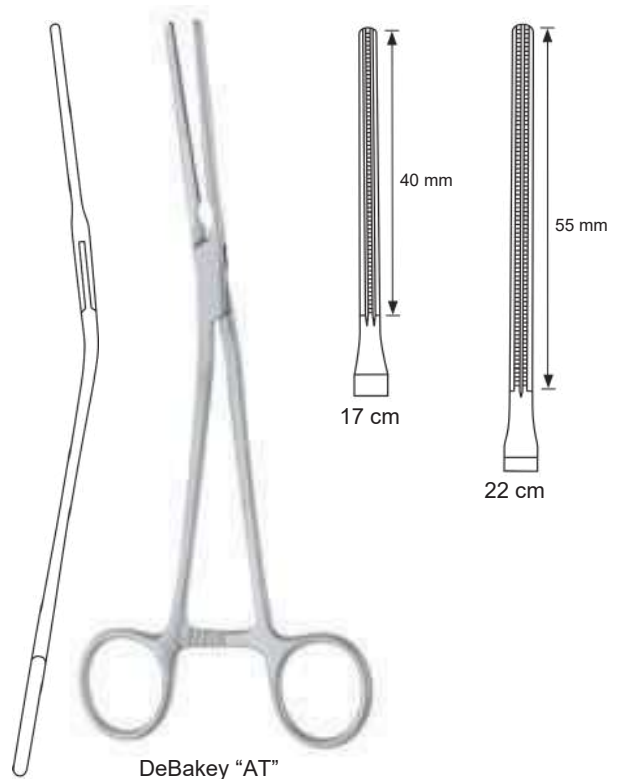

DeBakey "AT"
Coarctation clamps

Cardiovascular Clamps



Potts
Coarctation clamps

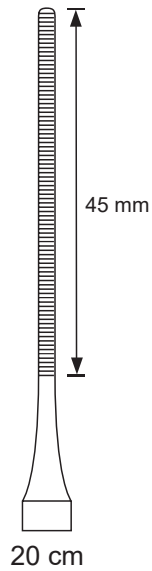

Cooley "AT"
Coarctation clamps



Cooley "AT"
Coarctation clamps

Cardiovascular Clamps

Anastomosis clamps

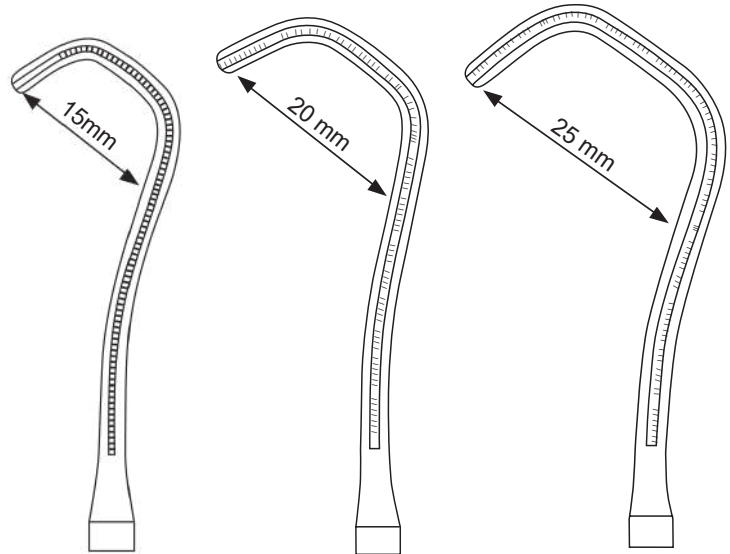

Derra-DeBakey "AT"

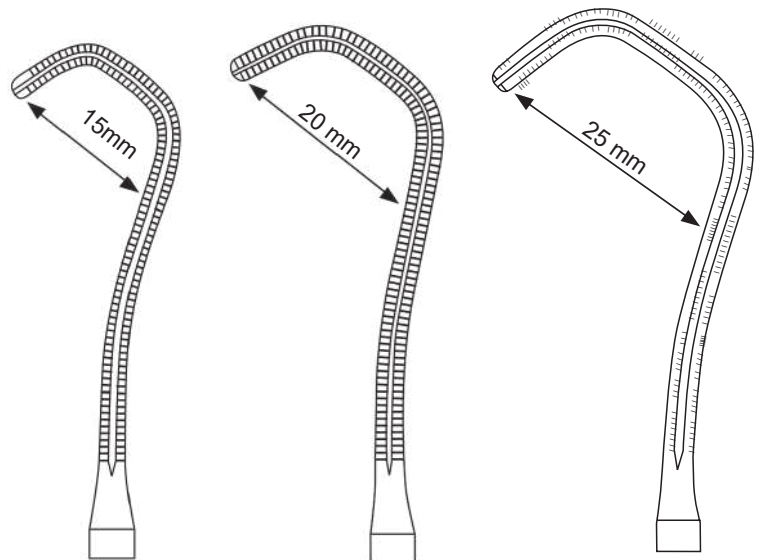

Derra-Cooley "AT"

Cardiovascular Clamps

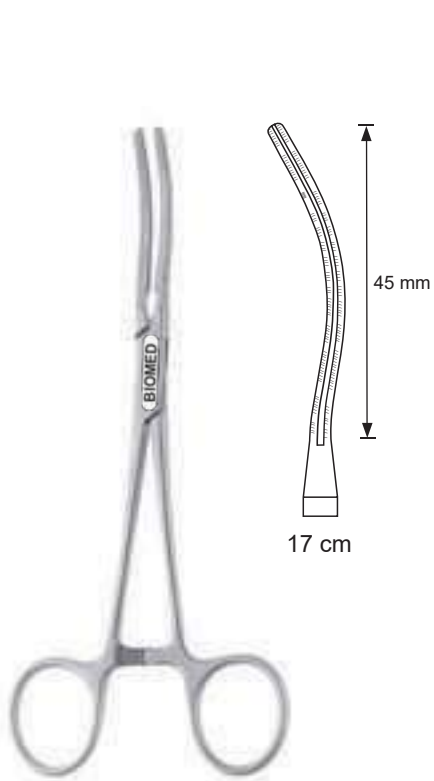

Cooley-Glover "AT"



Potts-Glover



Potts-Satinsky

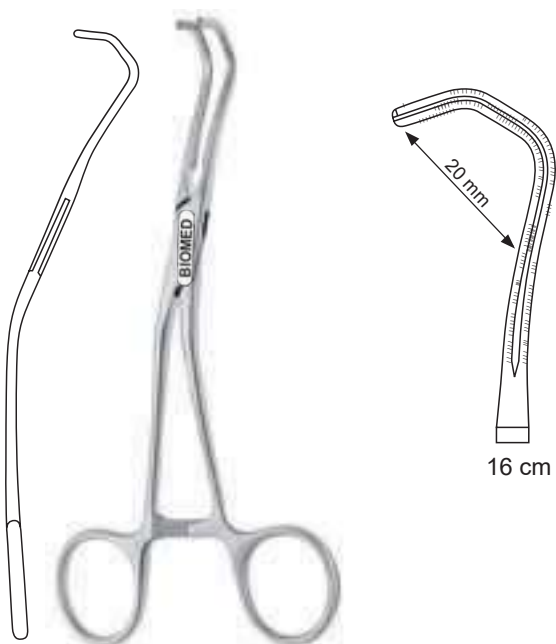

Cooley "AT"

Cardiovascular Clamps

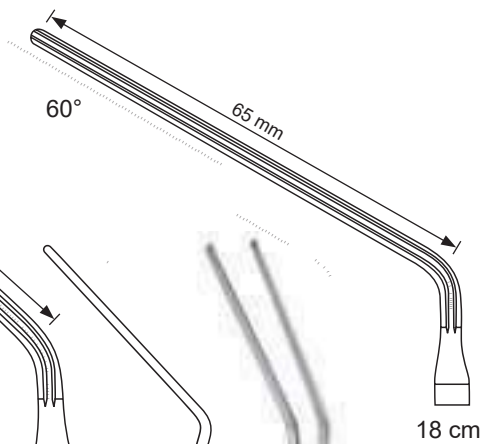
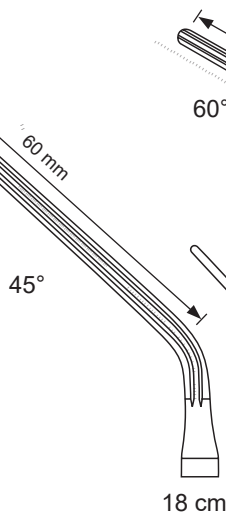
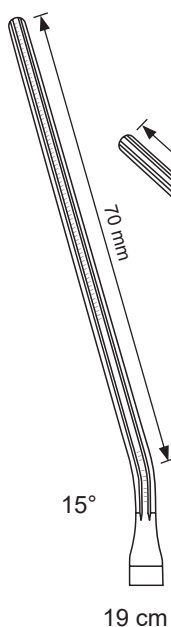
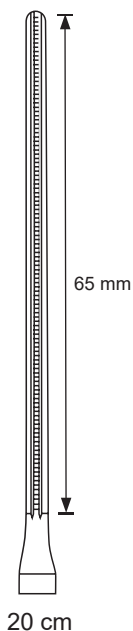

Leland-Jones "AT"
Peripheral vascular clamps

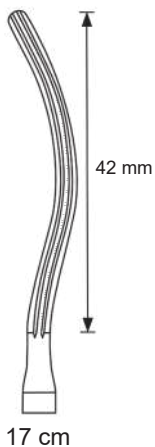

DeBakey-Glover "AT"
Anastomosis clamps

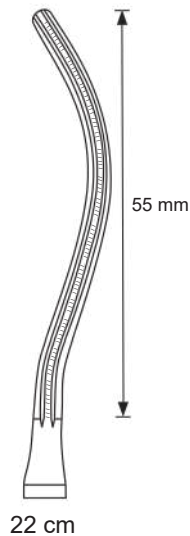

DeBakey-Glover "AT"
Anastomosis clamps

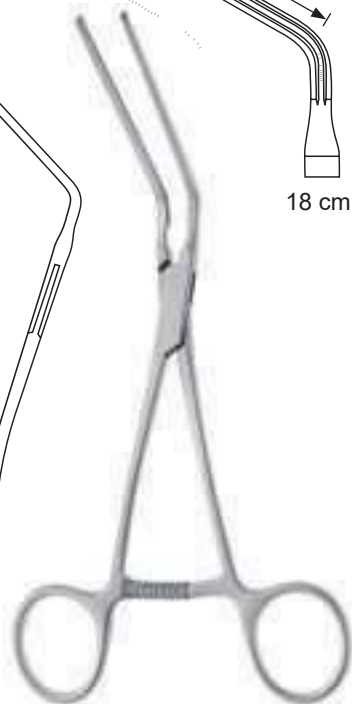

DeBakey "AT"
Peripheral vascular clamps

Cardiovascular Clamps

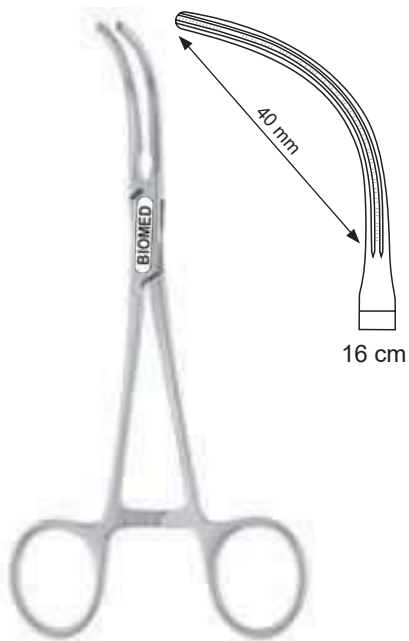

DeBakey "AT"
Peripheral vascular clamps

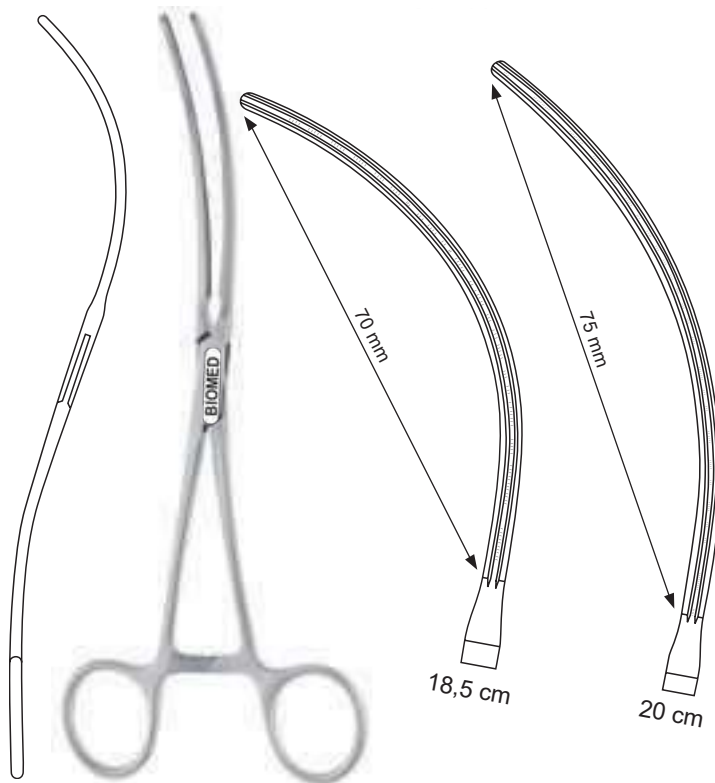

DeBakey "AT"
Peripheral vascular clamps



Dale "AT"
Peripheral vascular clamps

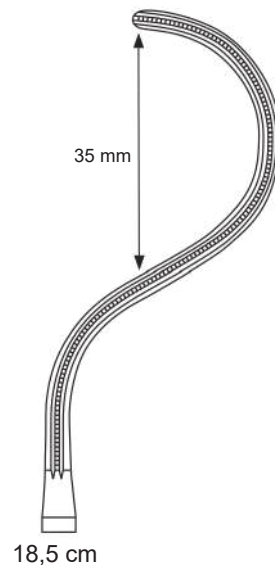
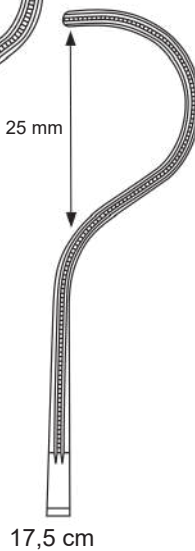
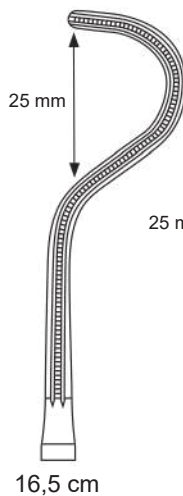
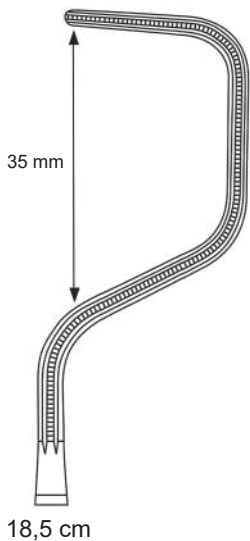

Cardiovascular Clamps

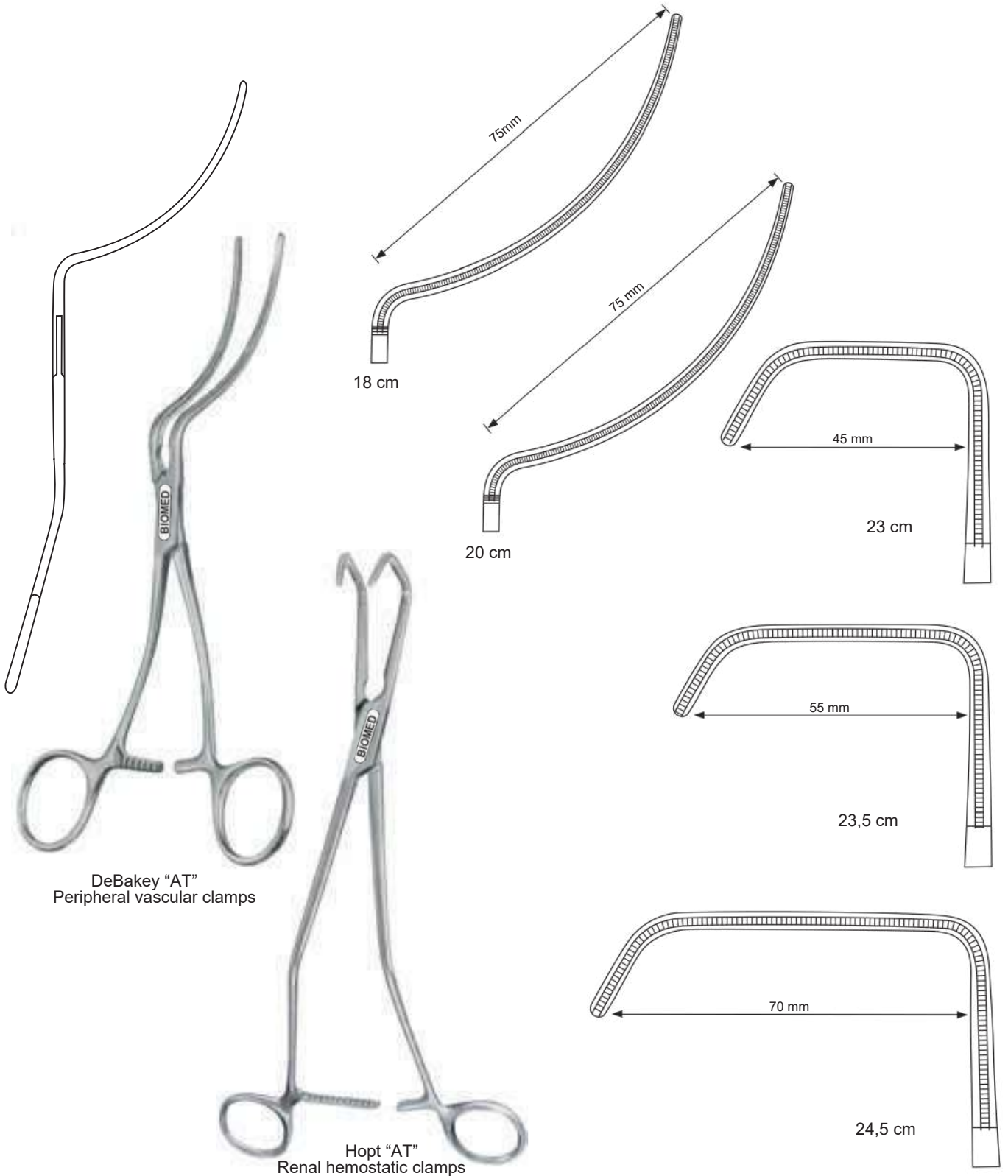

DeBakey "AT"
Peripheral vascular clamps

Hopt "AT"
Renal hemostatic clamps

Cardiovascular Clamps

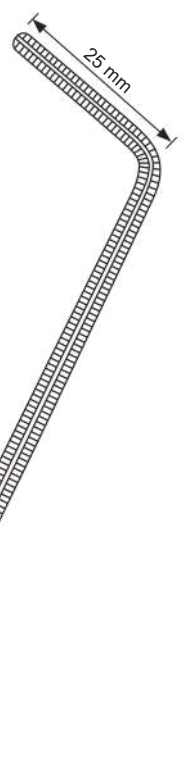
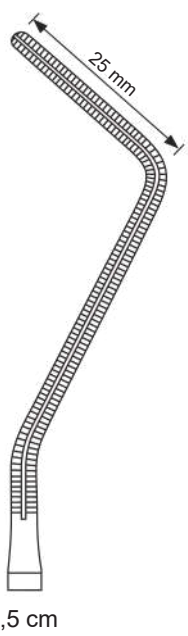
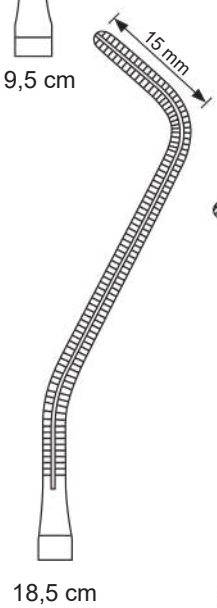
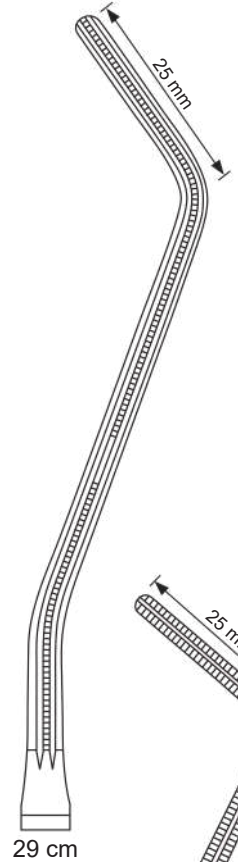
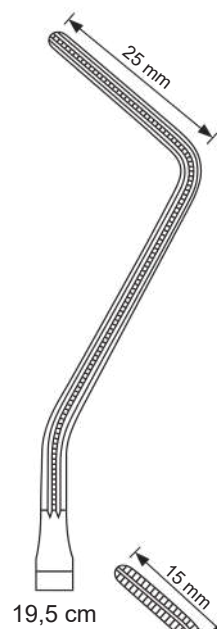
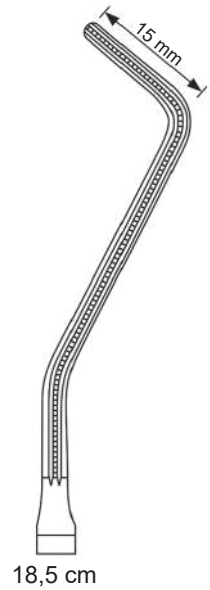

Cardiovascular Clamps

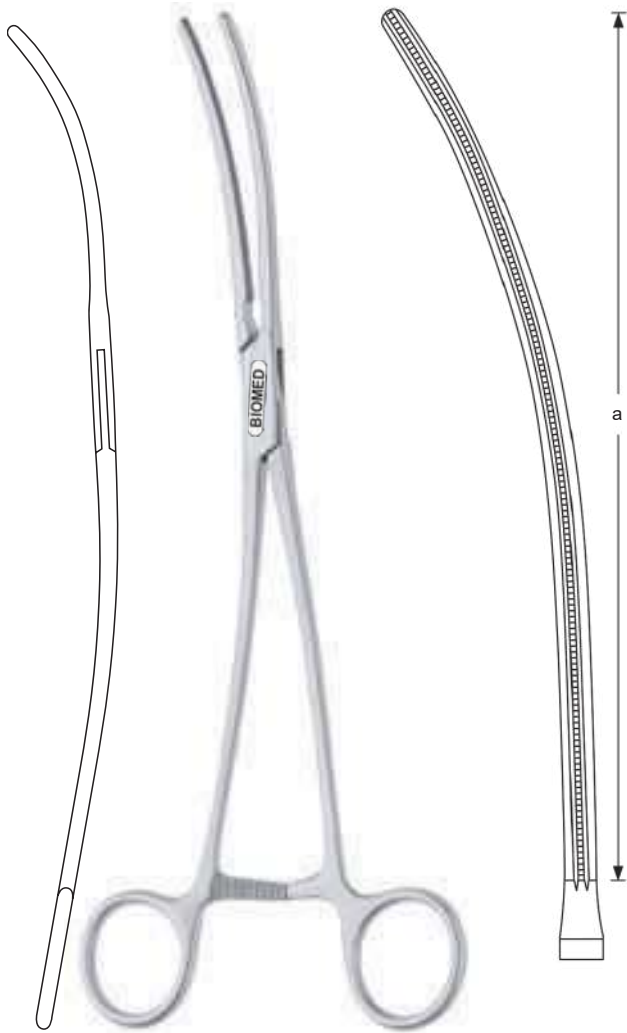

DeBakey "AT"
Aortic aneurysm clamps

L	a
26 cm	70 mm
27 cm	80 mm
30 cm	95 mm
32 cm	115 mm

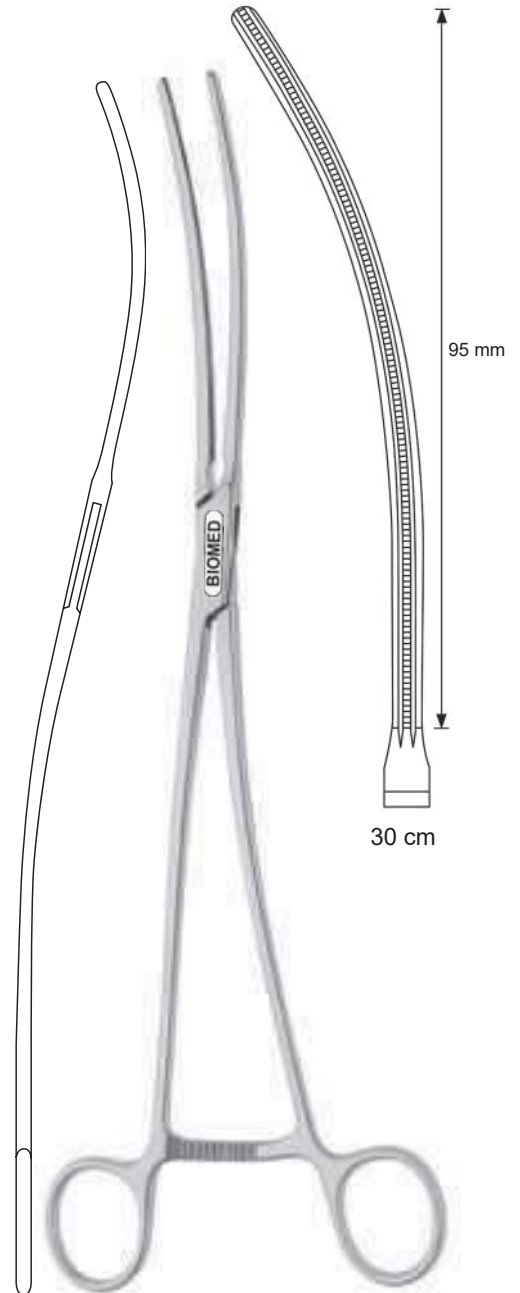

DeBakey "AT"
Aortic aneurysm clamps

Cardiovascular Clamps



Cardiovascular Clamps

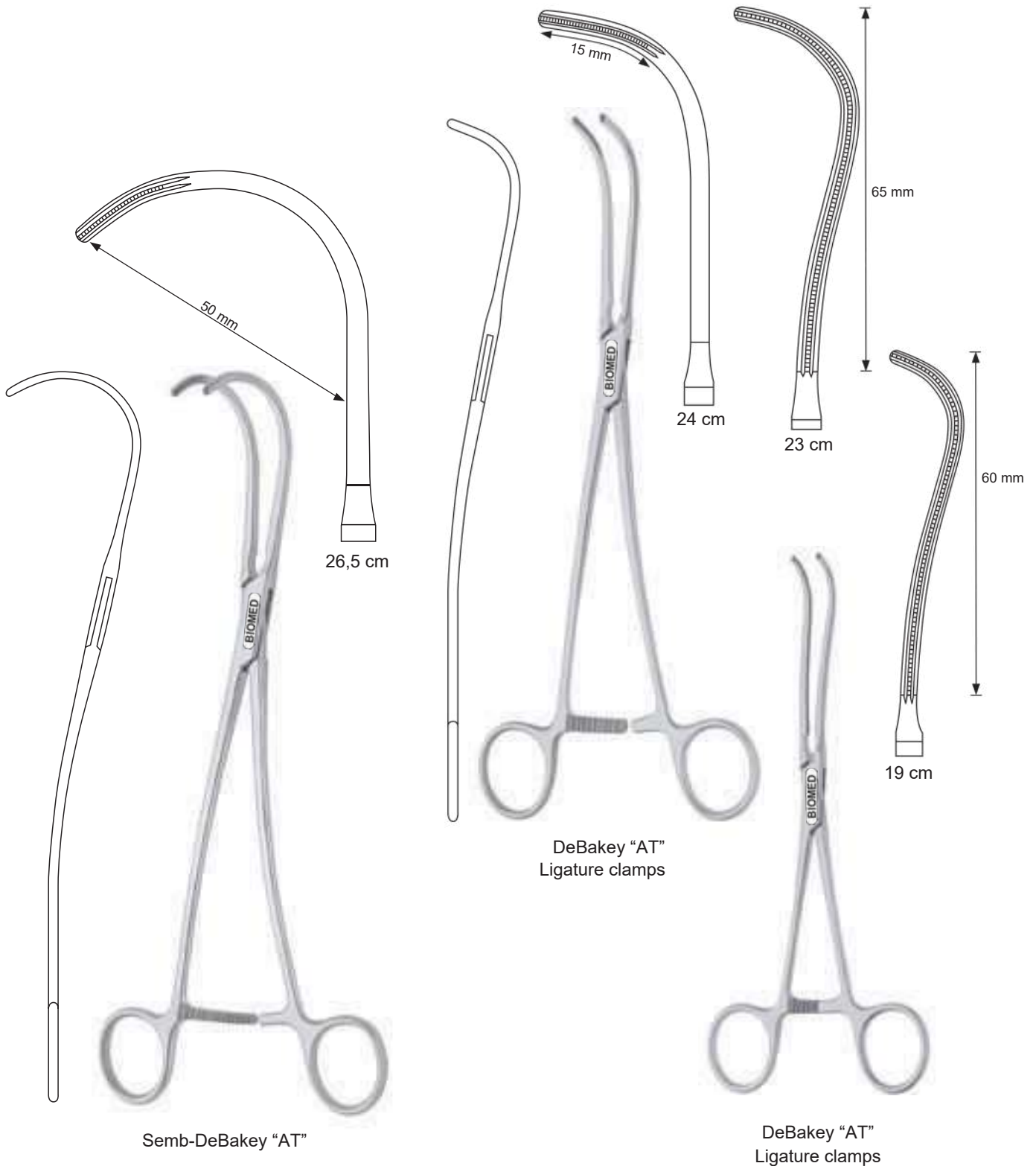

Cardiovascular Clamps

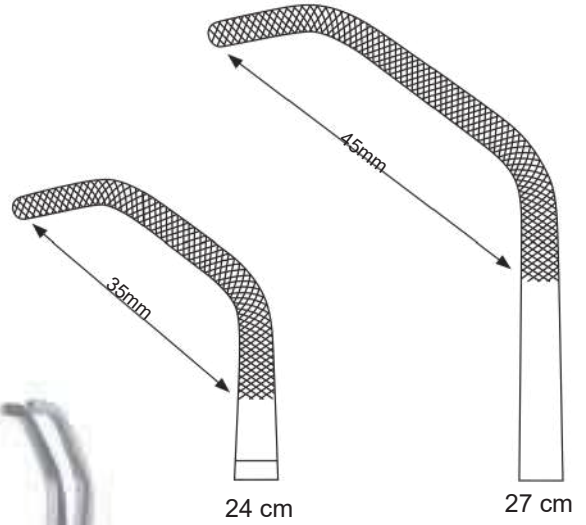
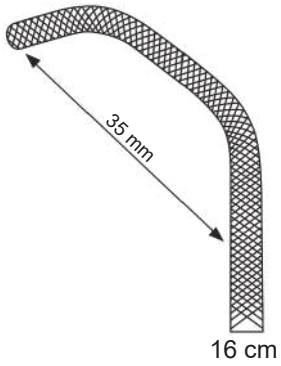

Satinsky-Baby
Vena cava clamps



Satinsky

Cardiovascular Clamps

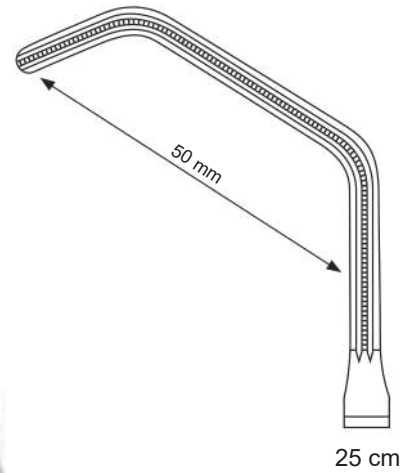
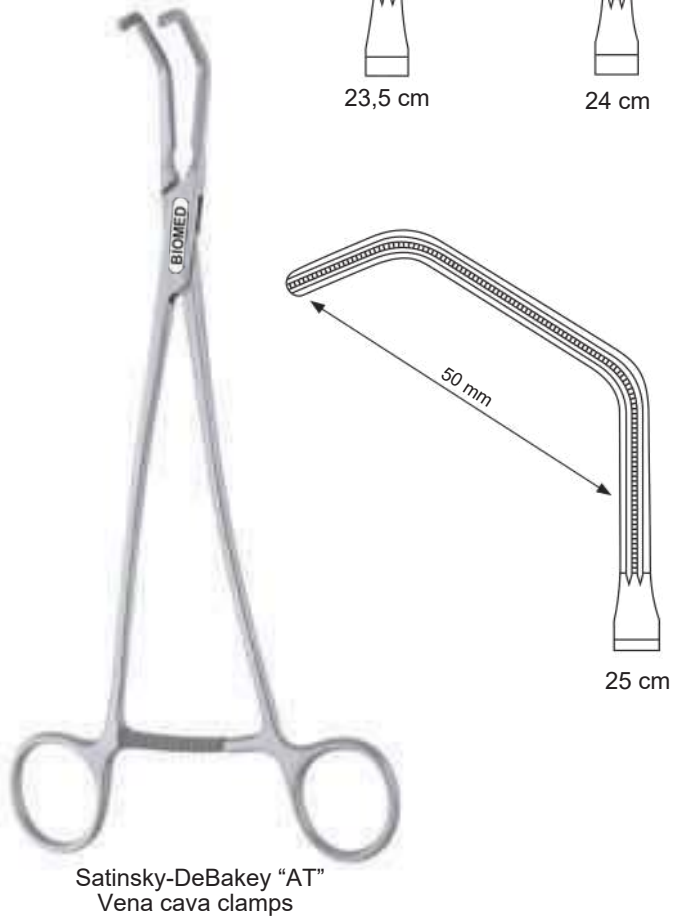
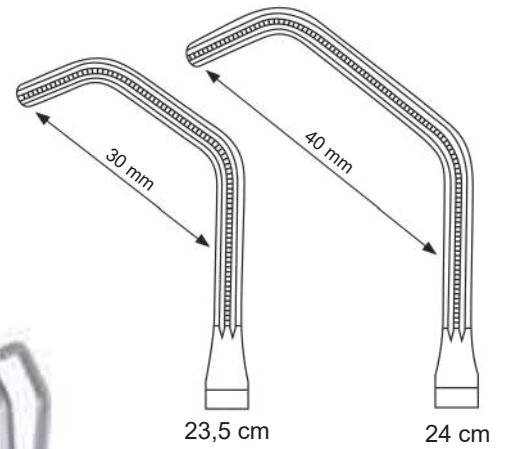
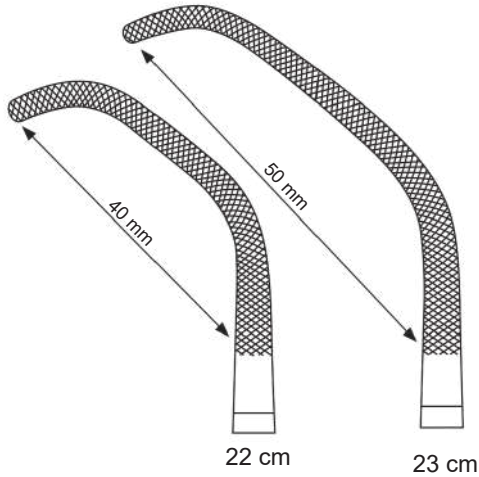

Cardiovascular Clamps

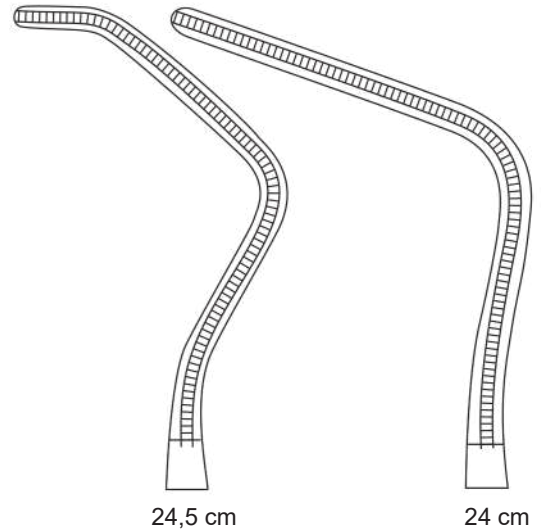
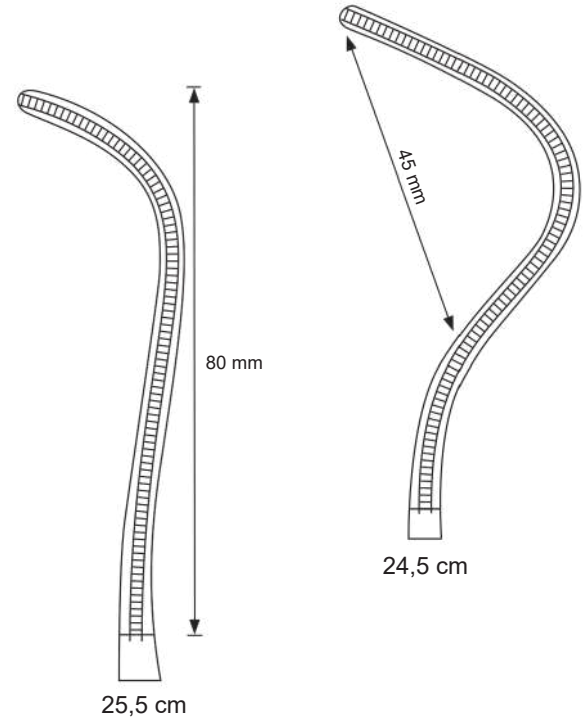
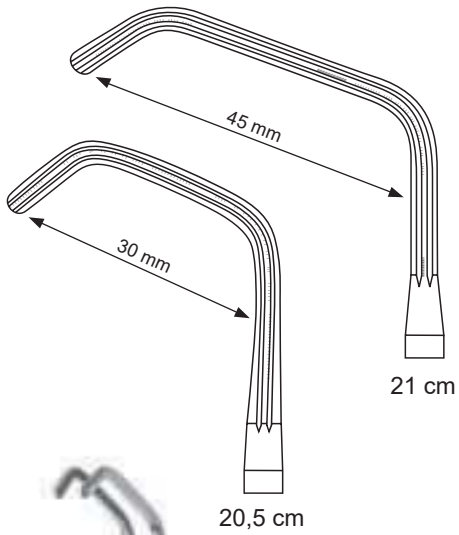

DeBailey Beck "AT"
Vena cava clamps

DeBailey Harken "AT"

Cardiovascular Clamps

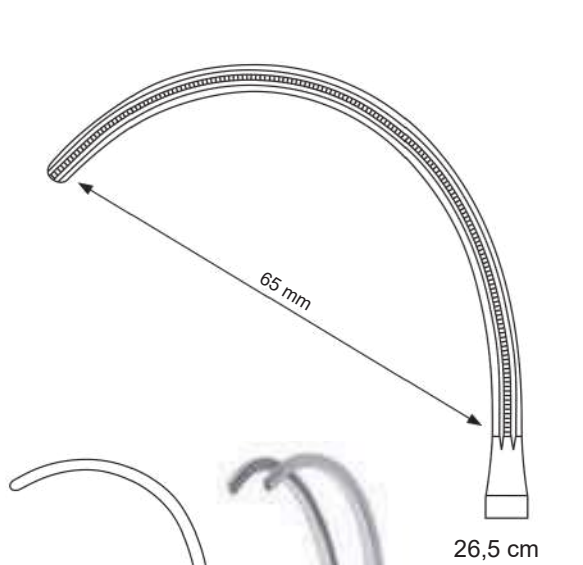

DeBakey "AT"
atraumatic serration

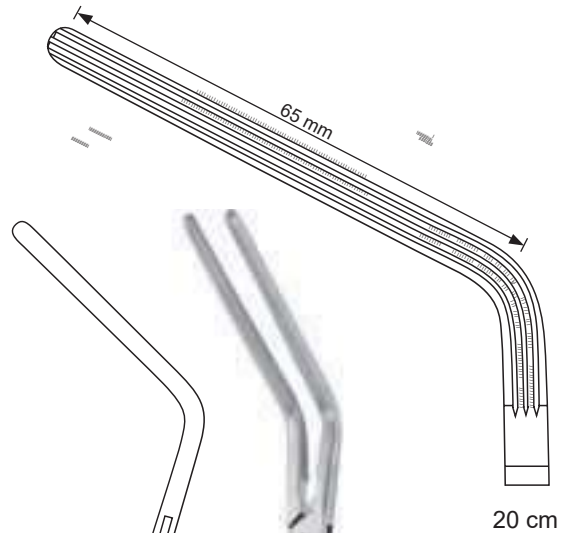
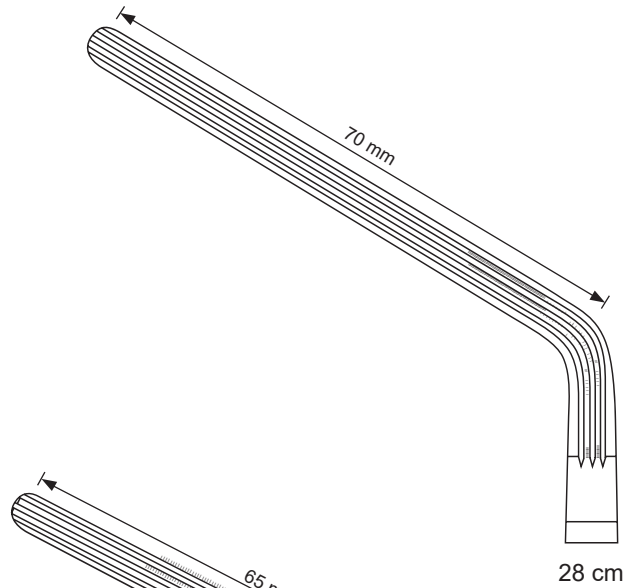

DeBakey "AT"
Aorta clamps

Cardiovascular Clamps

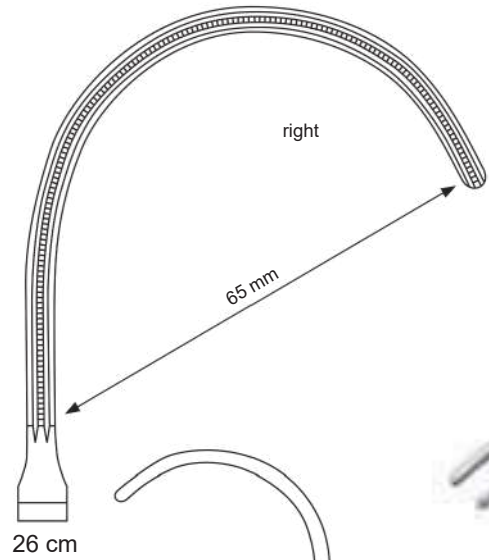
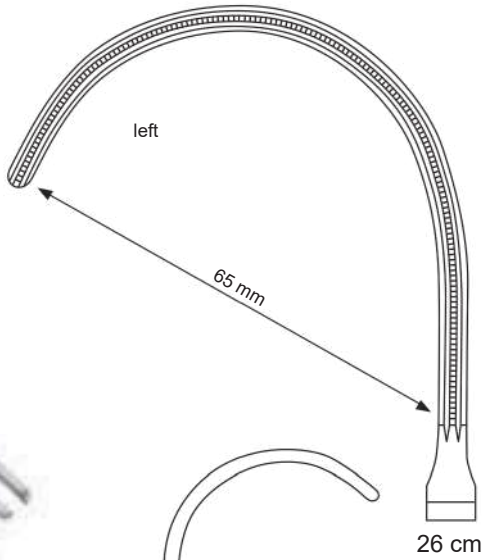

Weber "AT"
Aorta clamps



Weber "AT"
Aorta clamps

Cardiovascular Clamps



Neonatal

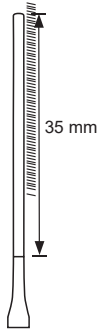

12,5 cm

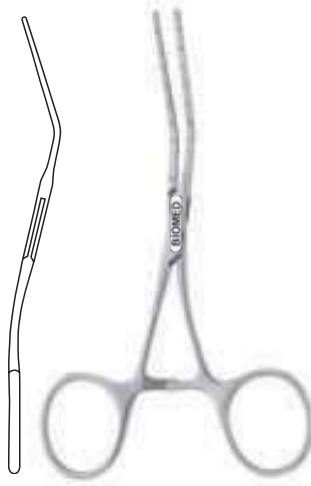

Neonatal

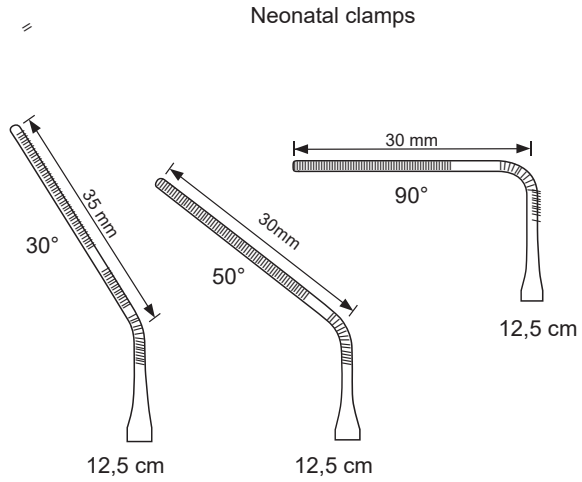

Cooley "AT"

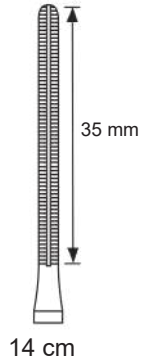

14 cm



Cooley "AT"

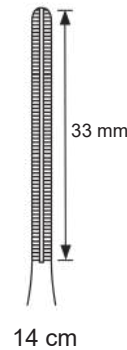

14 cm

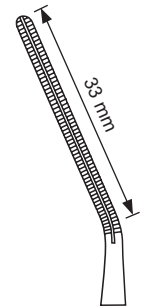

14 cm

Cardiovascular Clamps



Neonatal



Neonatal

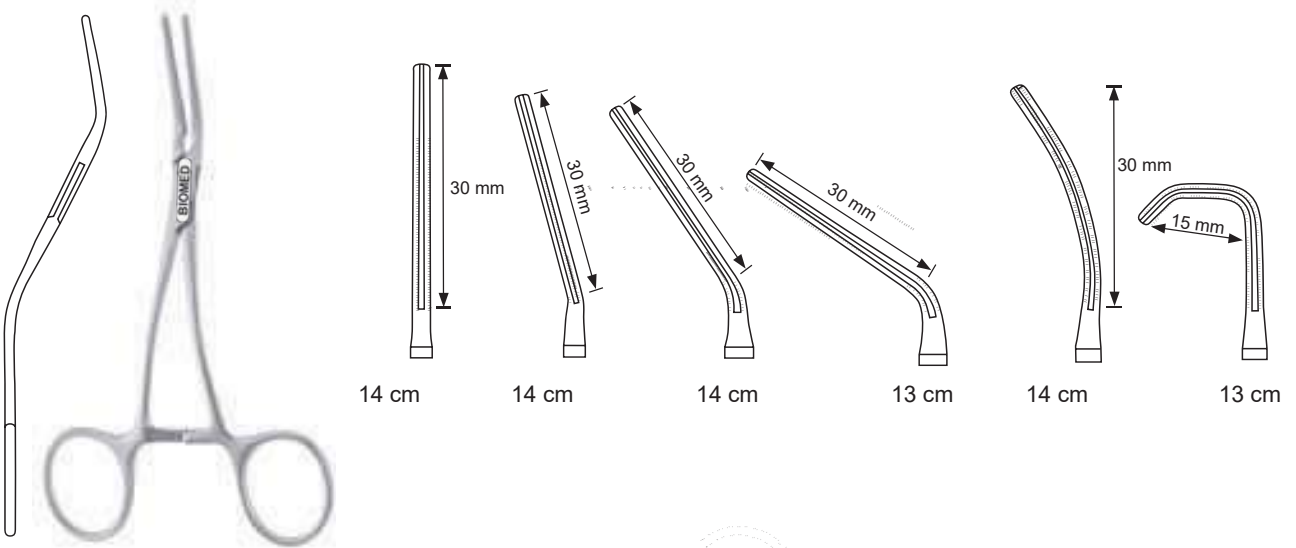

Cooley "AT"

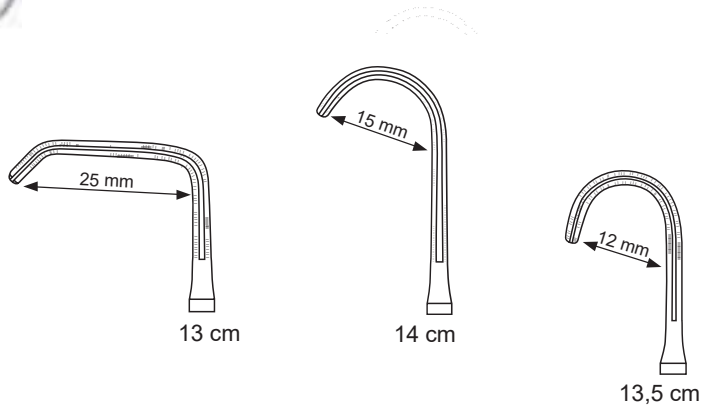

Cardiovascular Clamps

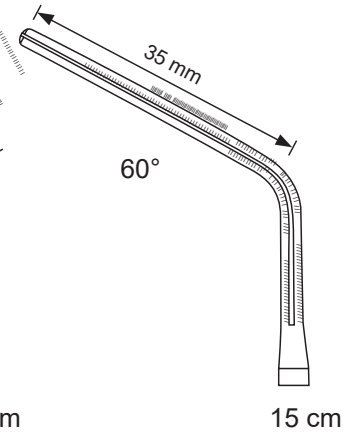
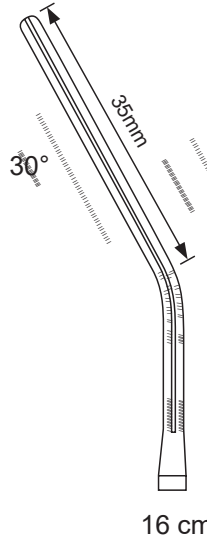
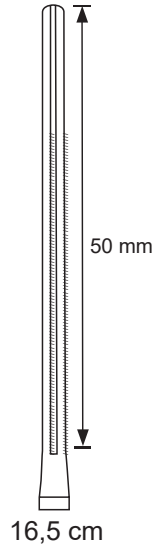

Cooley "AT"
Neonatal clamps



Cooley "AT"
Neonatal clamps

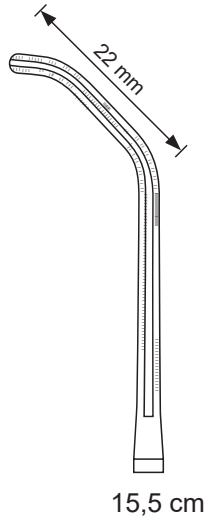
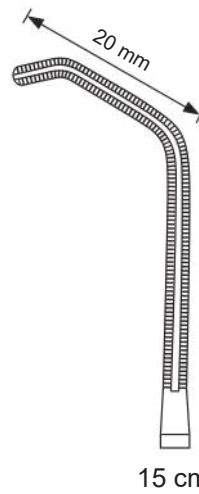

Cardiovascular Clamps



Lambert-Kay "AT"
Aorta clamp



Subramanian "AT"

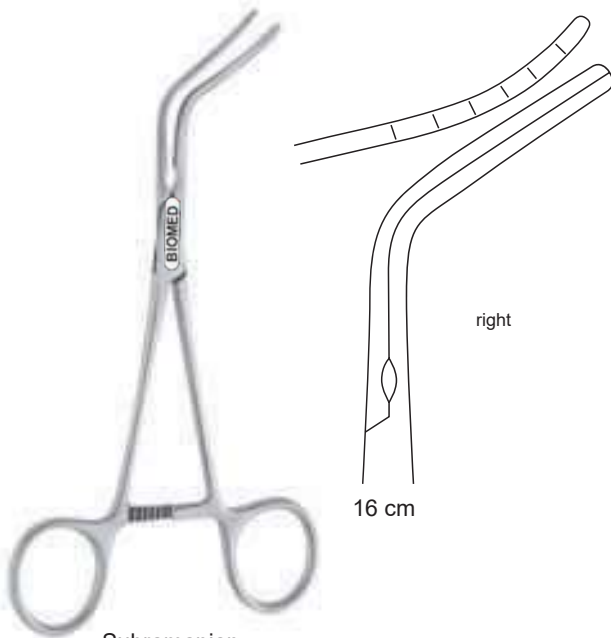

Subramanian

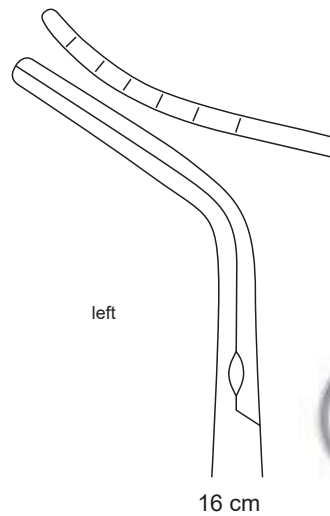

16 cm



Subramanian

Cardiovascular Clamps

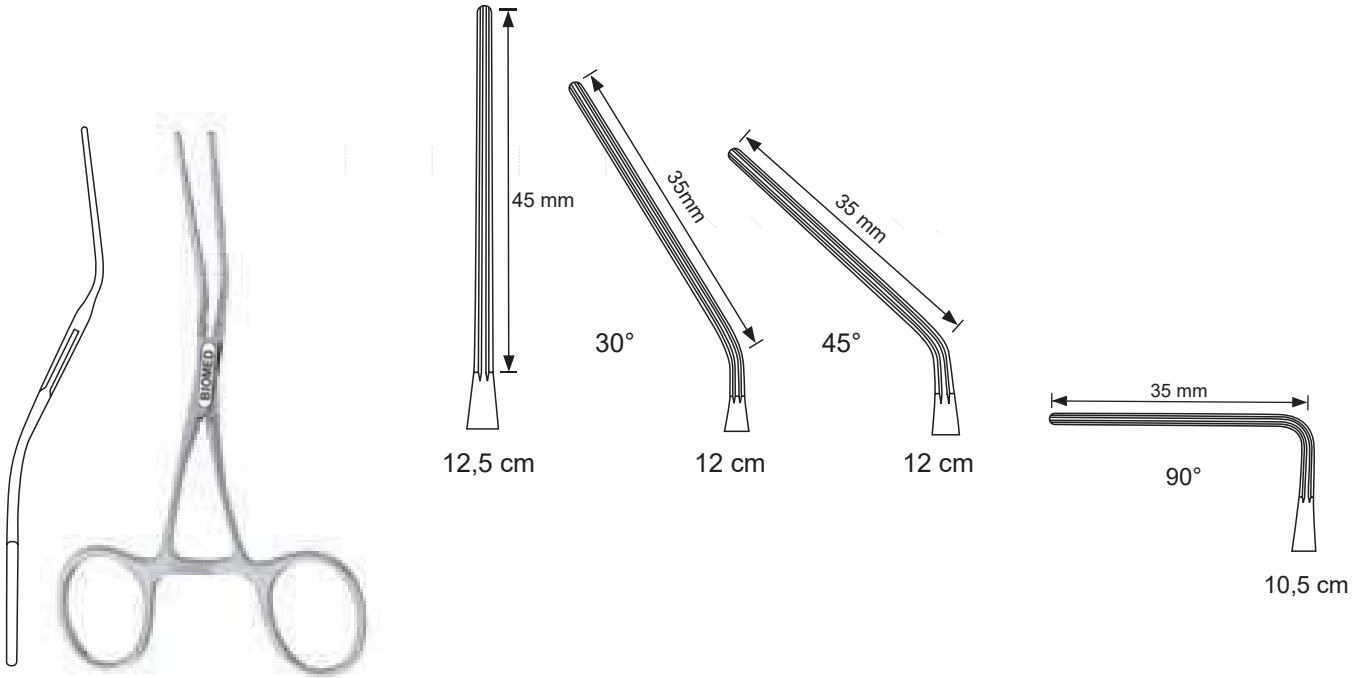

Castaneda "AT"
Neonatal



Castaneda "AT"
Neonatal

Tissue Forceps

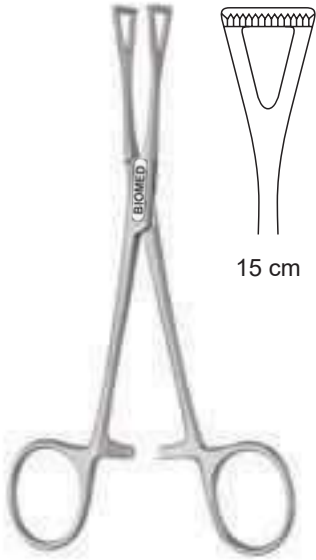

15 cm

Collin

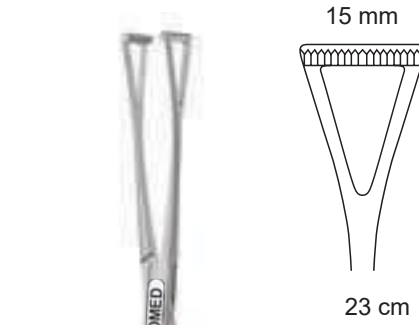

15 mm

20 mm

23 cm

21 cm

Duval

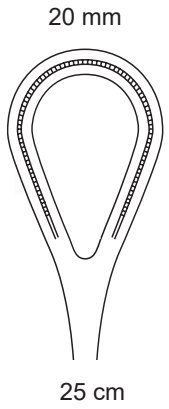

20 mm

25 cm



25 mm

23 cm

Duval "AT"



25 mm

27 cm

DeBakey "AT"

Vascular Clamps, Titanium

Titanium DeBakey Paediatric Clamp
14CM length
Straight jaws/angled shanks



Titanium DeBakey Paediatric Clamp
14CM length
Straight jaws/angled shanks

Jaws angled 30°
Jaws angled 45°
Jaws angled 60°



Titanium DeBakey Paediatric Clamp
14CM length



Titanium DeBakey Paediatric Clamp
14CM length



Titanium DeBakey Paediatric Clamp
14CM length



Rib & Sternal Spreader

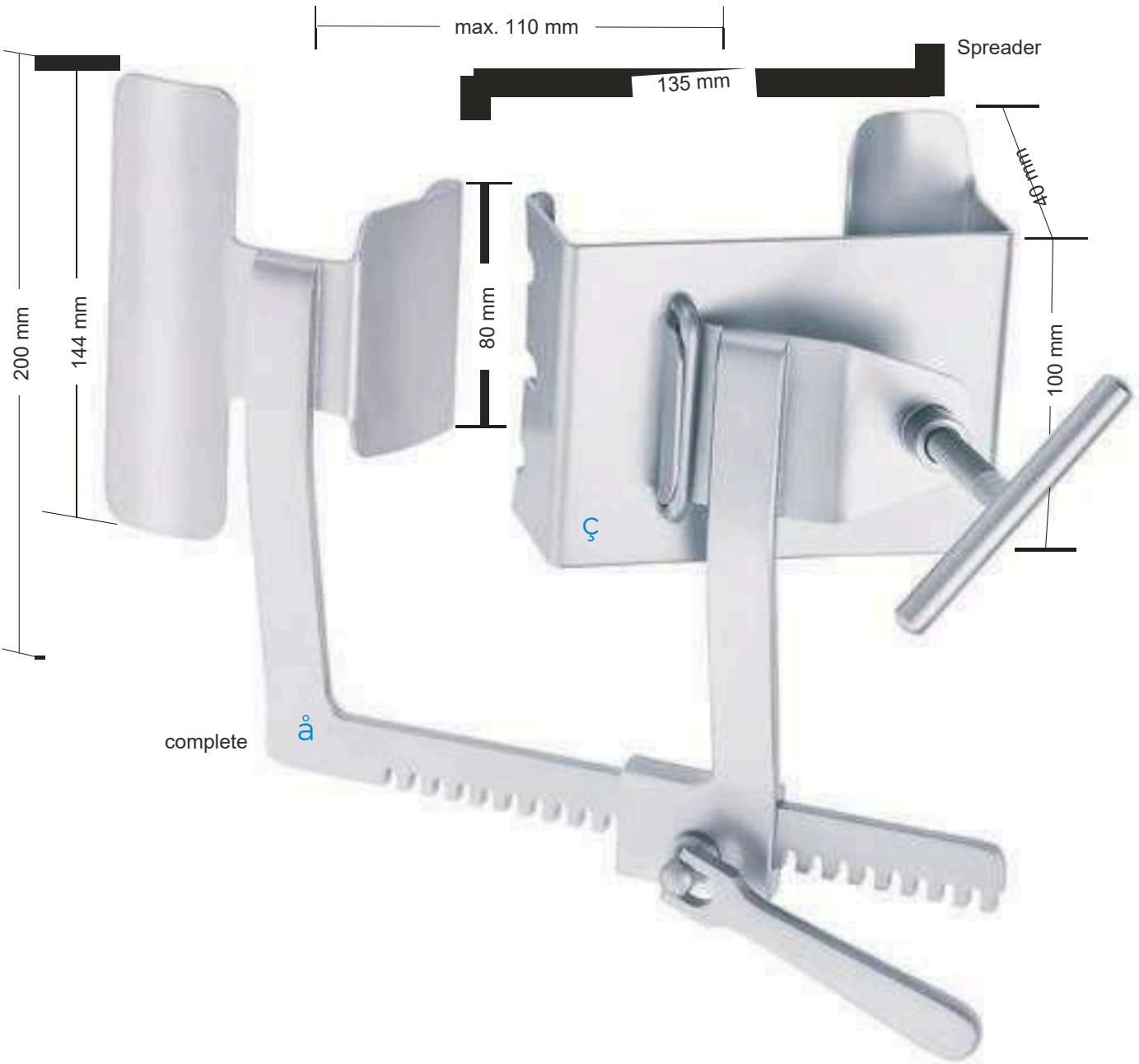

Rib & Sternal Spreader



Morse

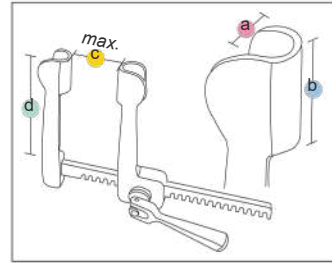

a b c d

	mm	mm	mm	mm	
stainless steel	20	28	200	150	for adults
stainless steel	20	20	160	120	for children



Morse Favaloro

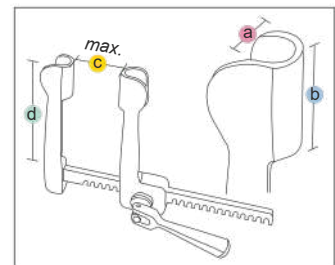



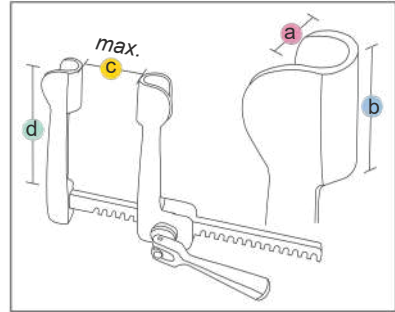
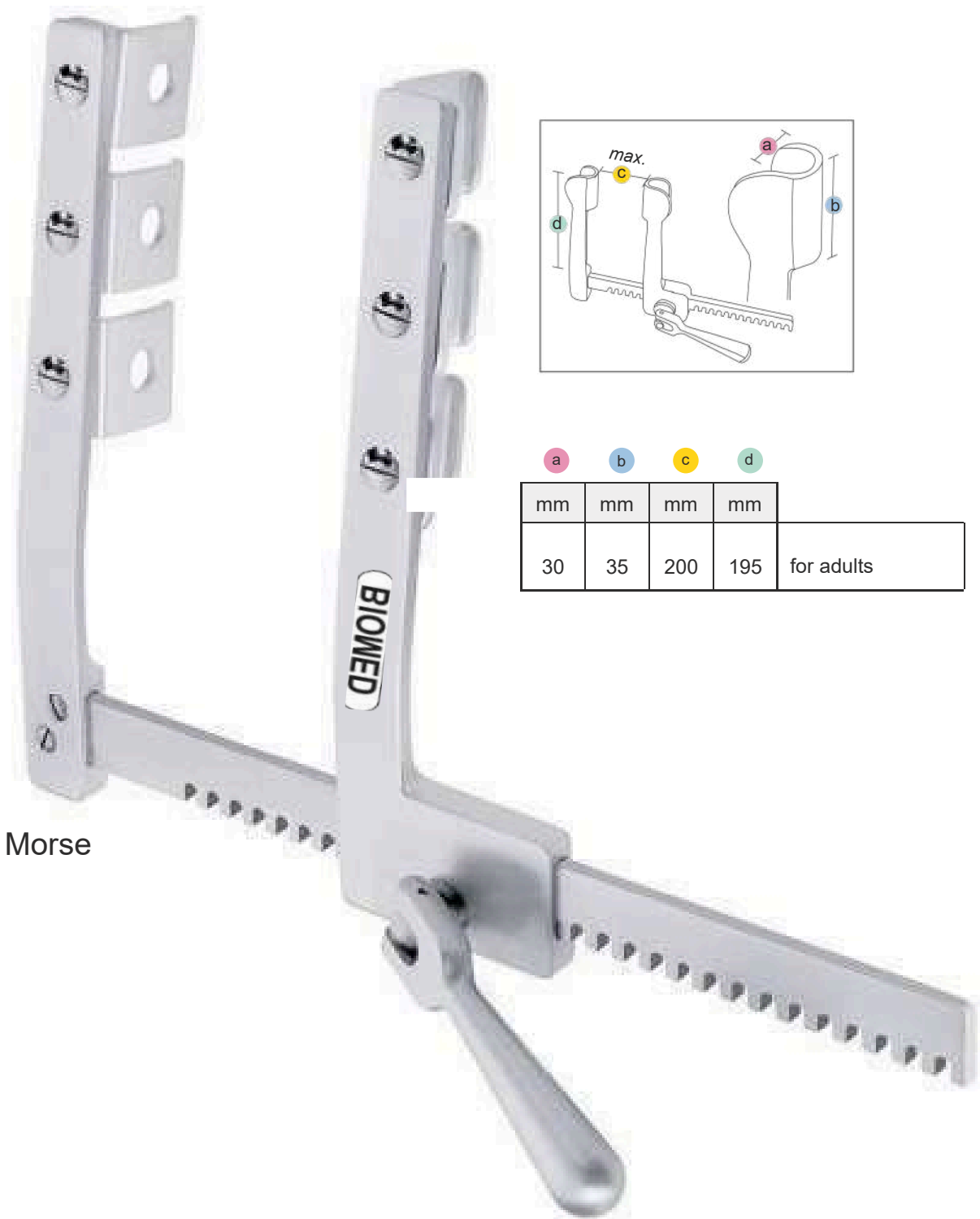

a b c d

	mm	mm	mm	mm	
stainless steel	40	20	155	175	for adults
stainless steel	12	20	155	120	for children

Rib & Sternal Spreader



				
mm	mm	mm	mm	
30	35	200	195	for adults

Rib & Sternal Spreader

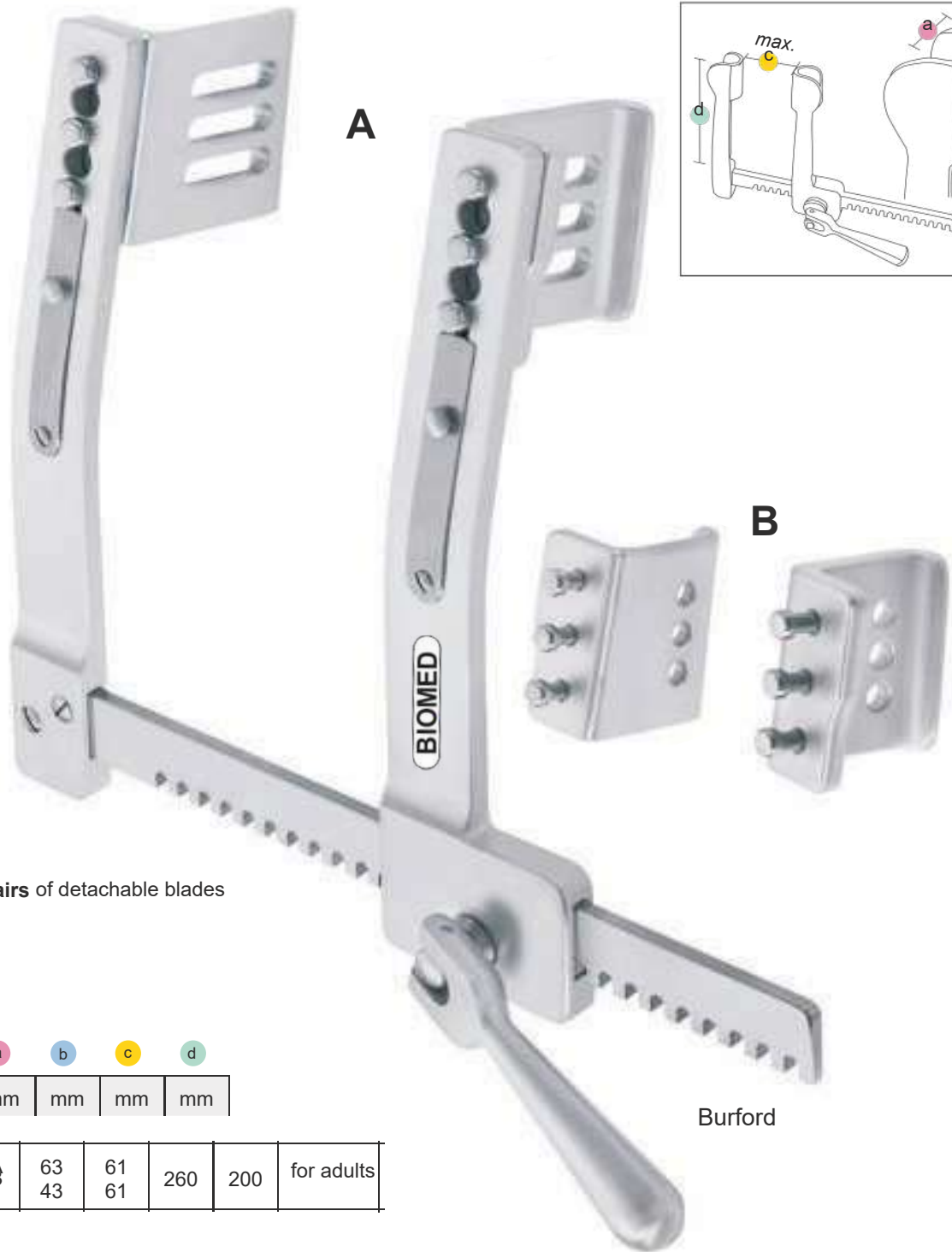

with **2 pairs** of detachable blades

a	b	c	d
mm	mm	mm	mm

stainless steel	A B	63 43	61 61	260	200	for adults
-----------------	--------	----------	----------	-----	-----	------------

Rib & Sternal Spreader

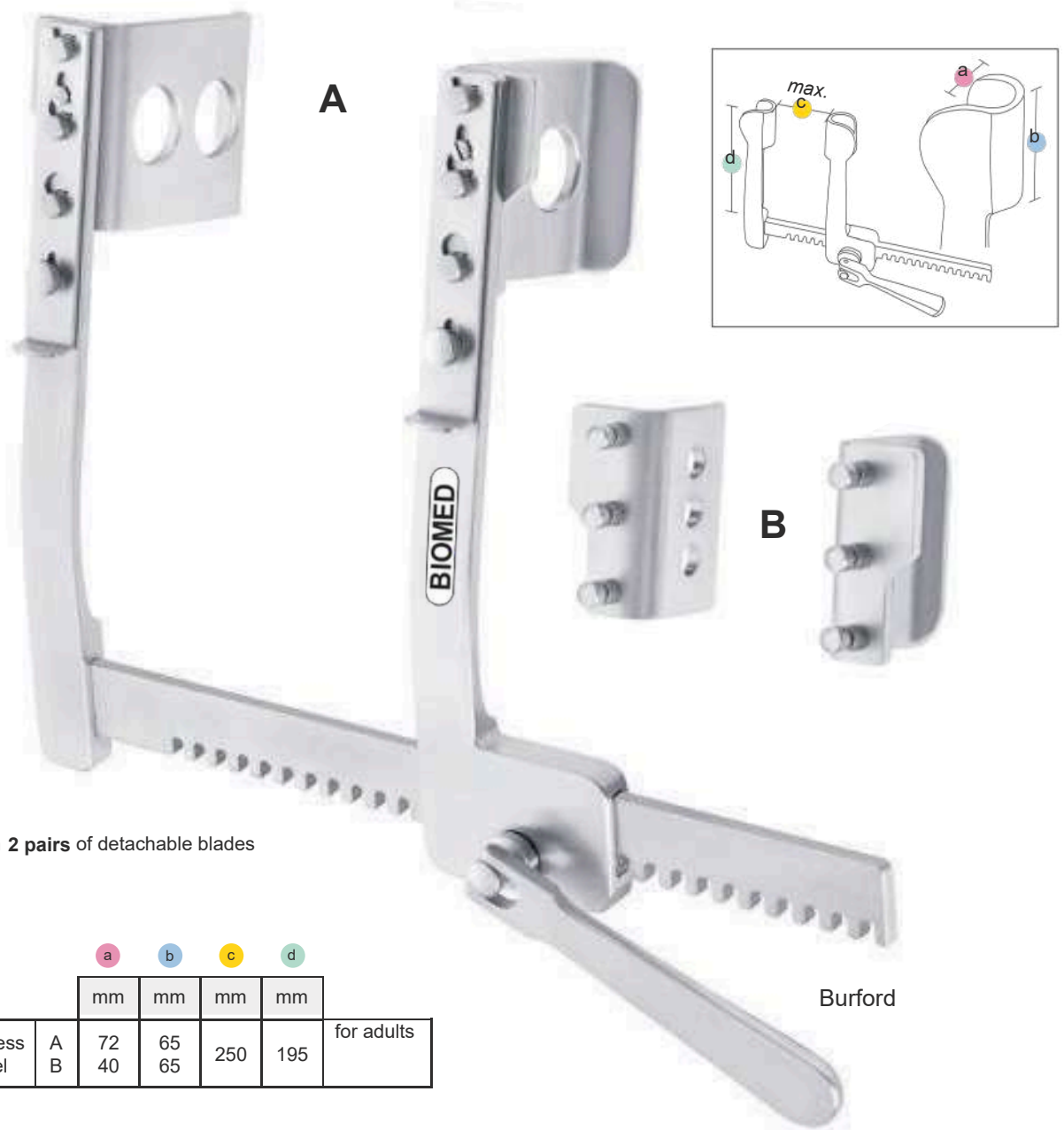

with 2 pairs of detachable blades

		a	b	c	d	
		mm	mm	mm	mm	
stainless steel	A	72	65	250	195	for adults
	B	40	65			

Burford

Rib & Sternal Spreader

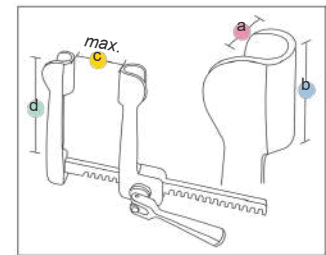
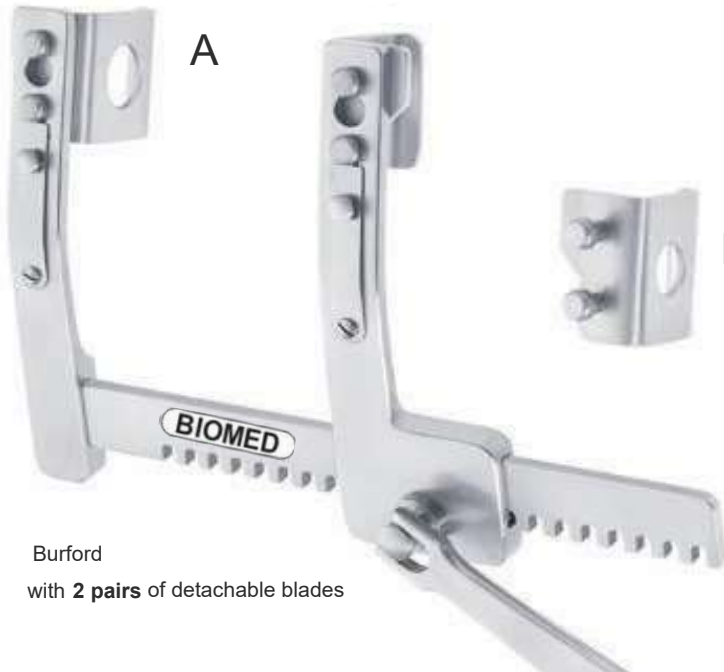

		a	b	c	d	
		mm	mm	mm	mm	
stainless steel	A	40	42	130	117	for children
	B	30	42			

Burford
with **2 pairs** of detachable blades

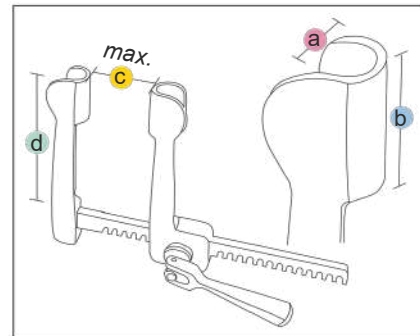

		a	b	c	d
		mm	mm	mm	mm
stainless steel	40	100	80	200	185
	50				
	60				

DeBaKey
with **3 pairs** of detachable blades

Rib & Sternal Spreader

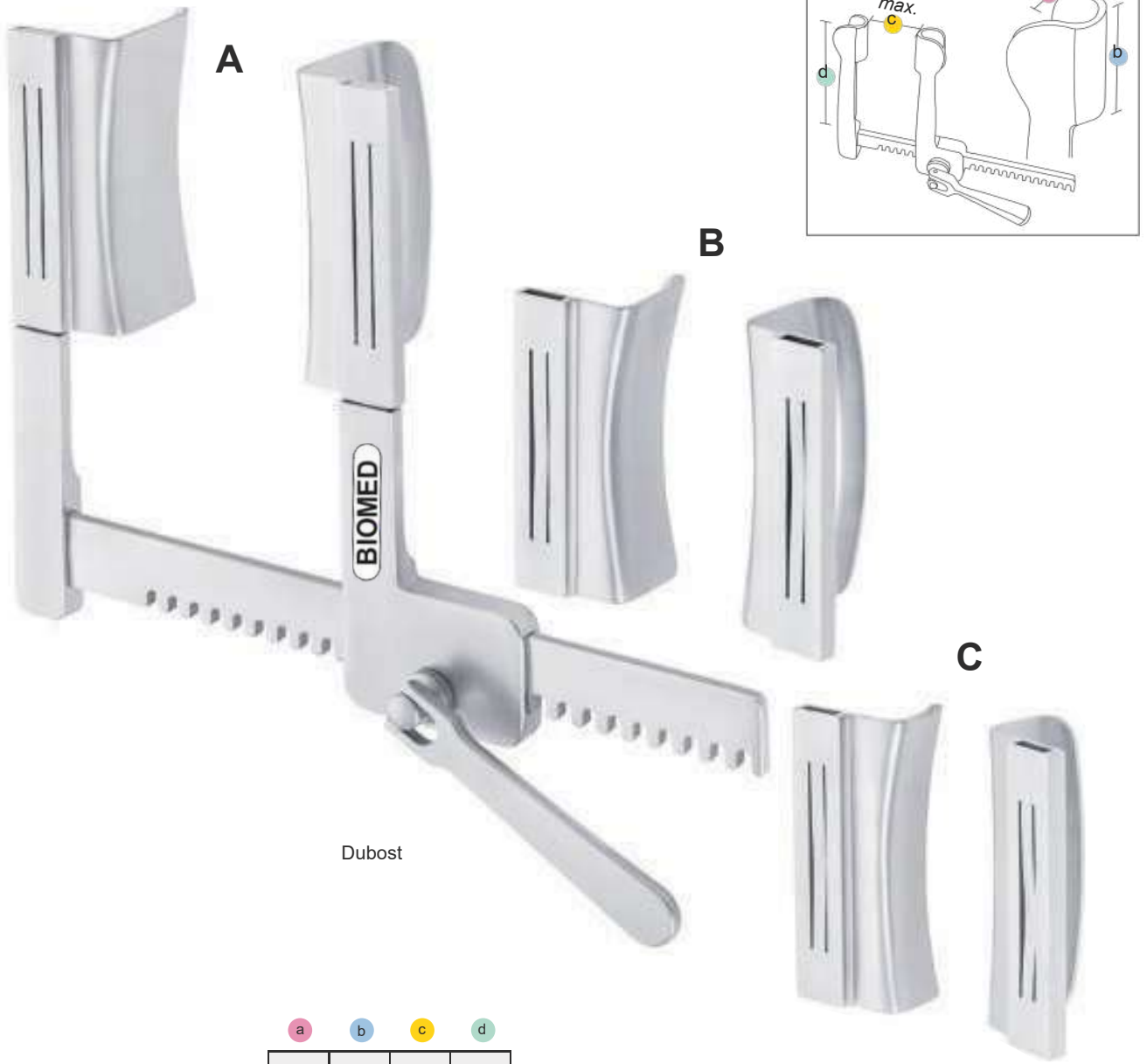

Dubost

with **3 pairs** of detachable blades

			a	b	c	d	
			mm	mm	mm	mm	
542376	stainless steel	A	50	100			adult
		B	40	100	160	160	
		C	30	100			

Rib & Sternal Spreader



with suture catcher

Ankeney

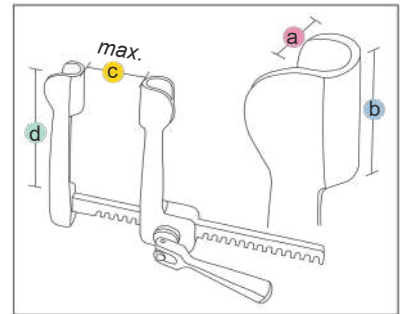

	a	b	c	d	
	mm	mm	mm	mm	
stainless steel	20	20	160	115	for children



with suture catcher

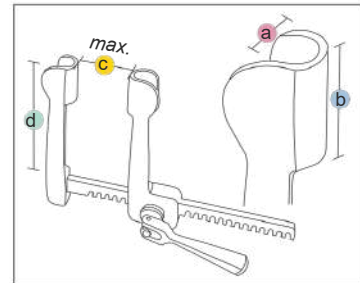

	a	b	c	d	
	mm	mm	mm	mm	
stainless steel	33	35	180	300	for adults

Rib & Sternal Spreader



Finochietto-Baby-Haight

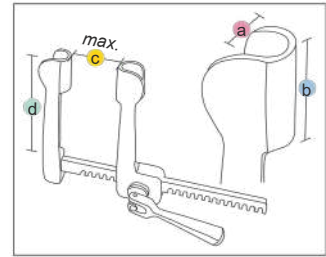

a b c d

	mm	mm	mm	mm	
stainless steel	28	30	100	75	for children

a b c d

	mm	mm	mm	mm	
stainless steel	12	15	70	55	for babies



Cooley

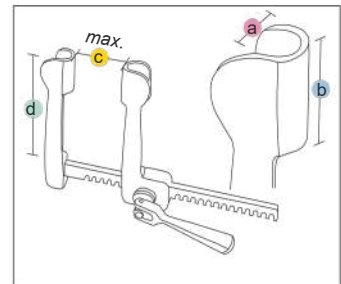

a b c d

	mm	mm	mm	mm	
	20	24	100	80	for babies

Rib & Sternal Spreader



Finochietto

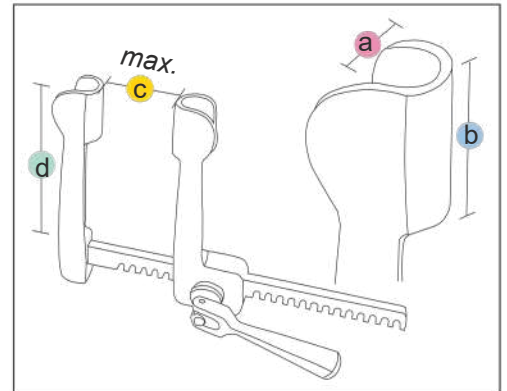

		a	b	c	d		
		mm	mm	mm	mm		
542260	stainless steel	6	7	36	25	for newborns	



Finochietto

		a	b	c	d		
		mm	mm	mm	mm		
		10	15	120	105	for infants	

Rib & Sternal Spreader

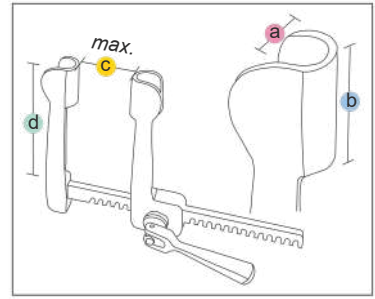

Rienhoff-Finochietto

		a	b	c	d	
		mm	mm	mm	mm	
542250	stainless steel	20	25	150	110	for adults and children



Baby-Haight

		a	b	c	d	
		mm	mm	mm	mm	
stainless steel		30	30	120	90	for adults
stainless steel		30	30	90	70	for children

Rib & Sternal Spreader



Finochietto

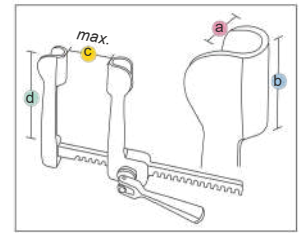

	a	b	c	d	
	mm	mm	mm	mm	
stainless steel	30	45	140	110	for adults and children
stainless steel	42	62	170	140	for adults, medium
stainless steel	73	65	170	140	for adults, large



Cooley

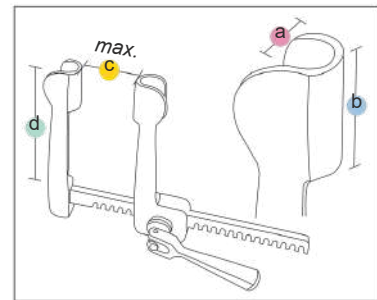

	a	b	c	d	
	mm	mm	mm	mm	
stainless steel	30	50	185	145	for adults
stainless steel	20	45	140	110	for children

Rib & Sternal Spreader



Tuffer

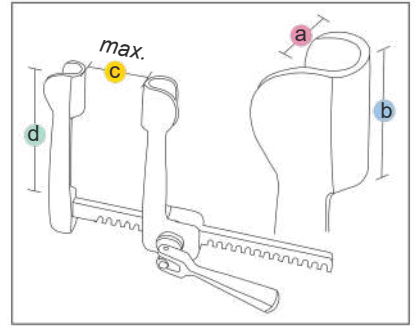

	a	b	c	d	
	mm	mm	mm	mm	
stainless steel	42	45	170	110	for adults

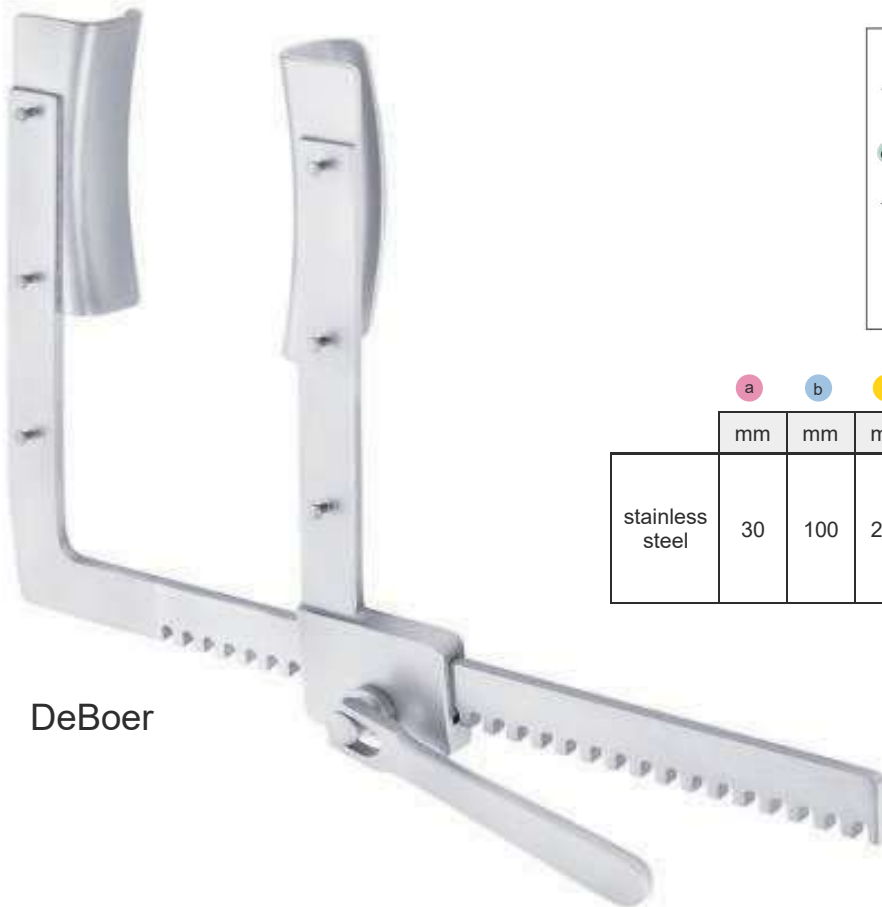

DeBoer

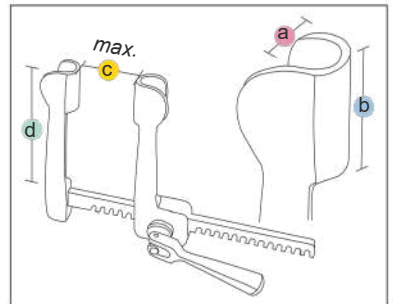

	a	b	c	d	
	mm	mm	mm	mm	
stainless steel	30	100	210	185	for adults

Rib & Sternal Spreader

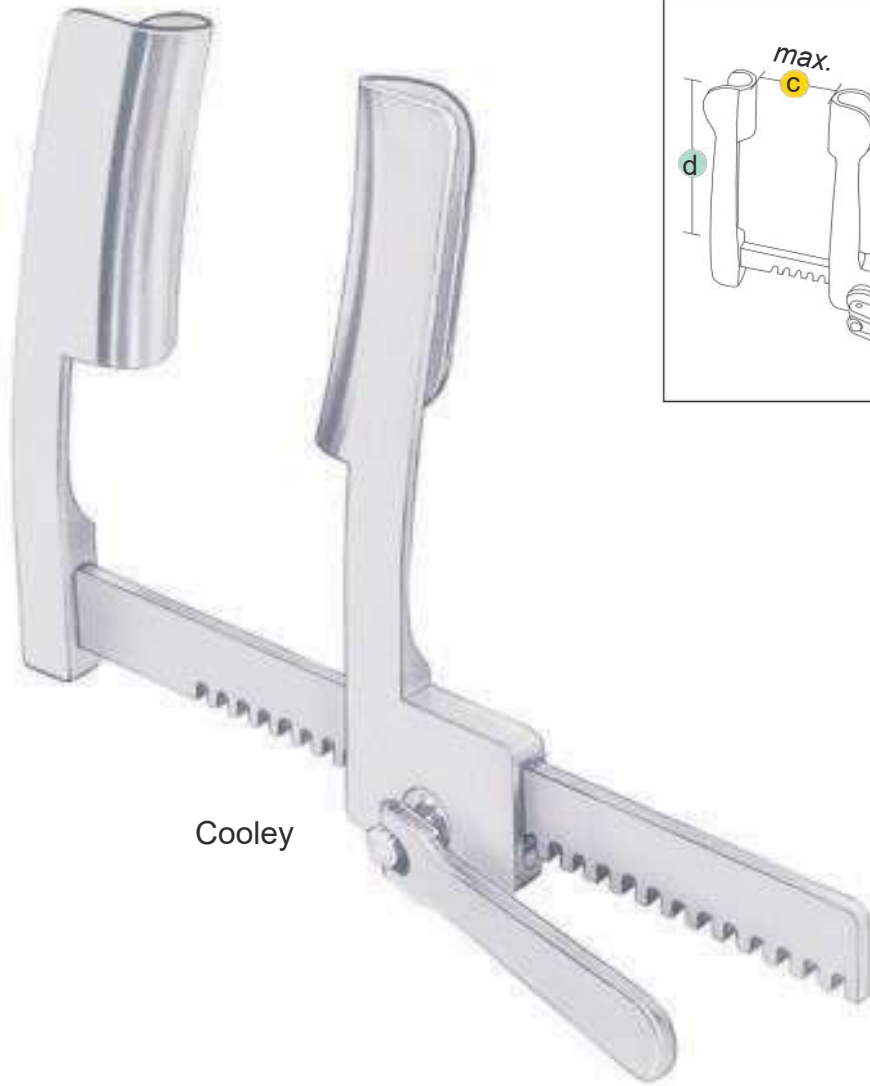

Cooley

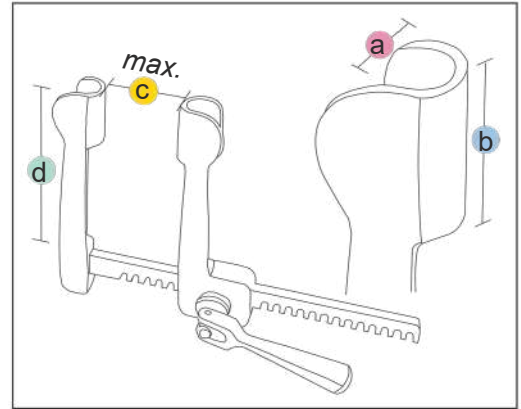



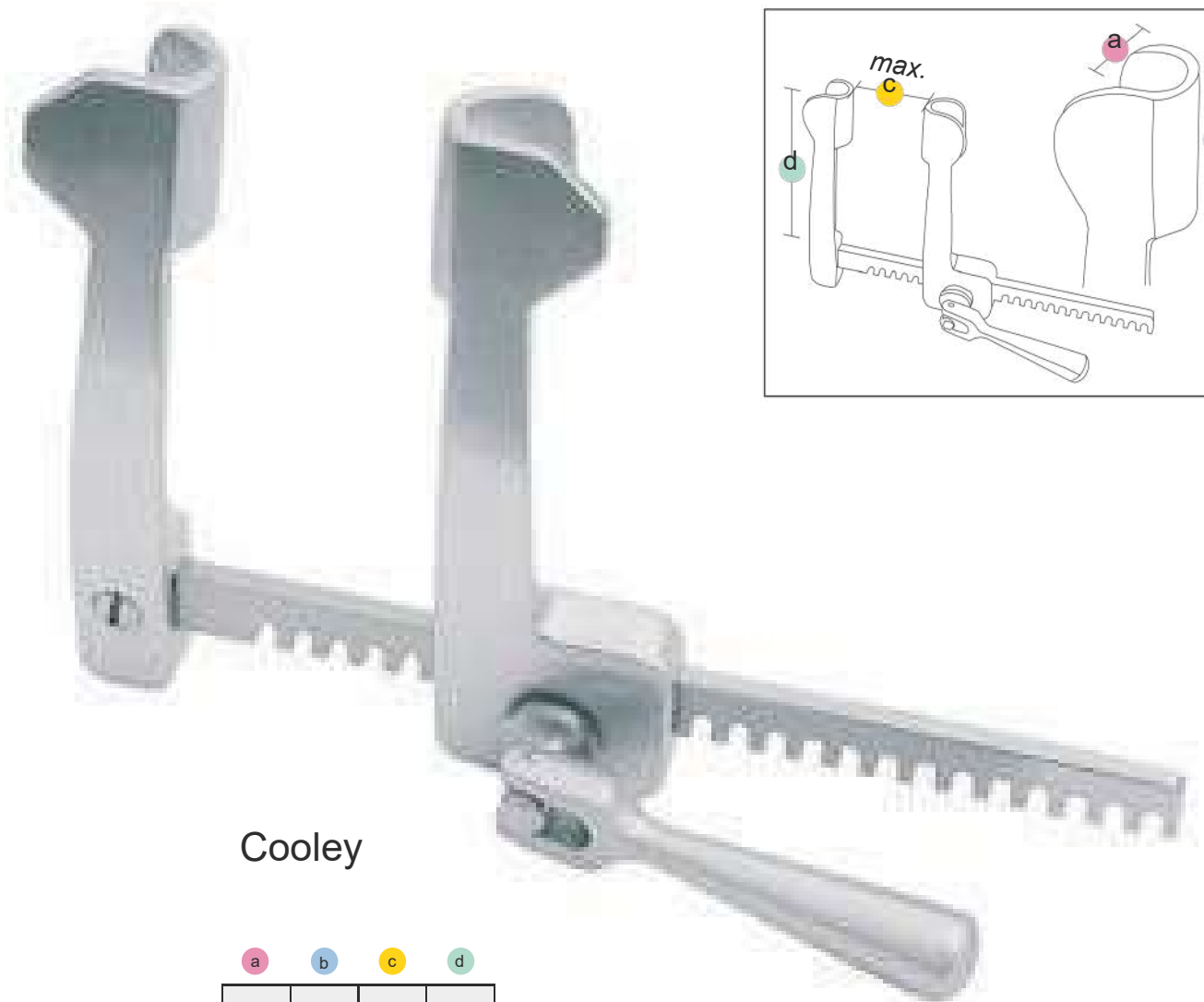

	a	b	c	d	
	mm	mm	mm	mm	
stainless steel	35	110	230	205	for adults

Rib & Sternal Spreader



Cooley

 a	 b	 c	 d	
mm	mm	mm	mm	
12	17	95	55	for babies
15	30	140	80	for children

Rib & Sternal Spreader

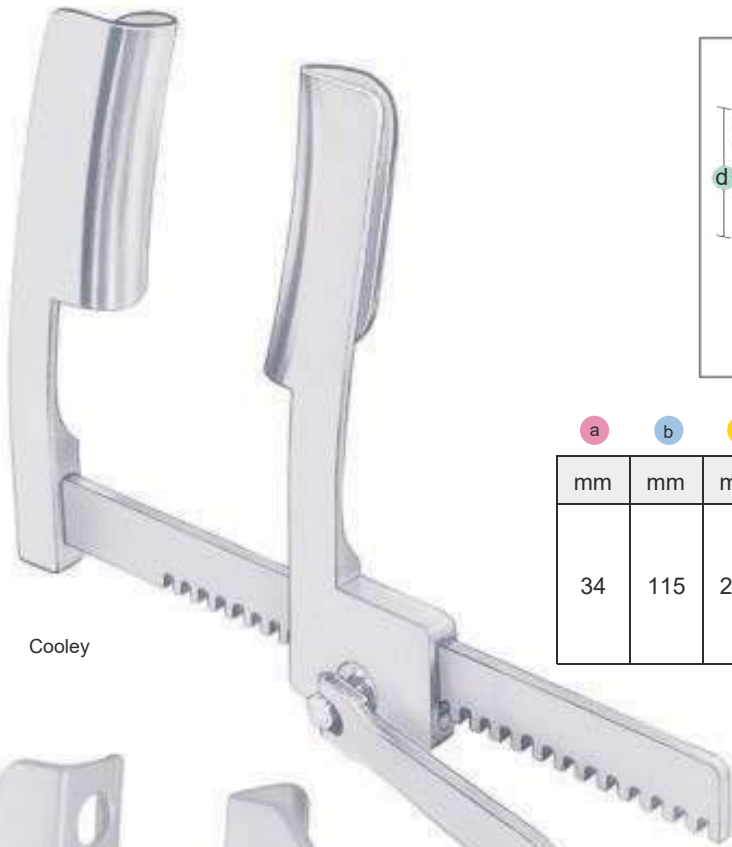

Cooley

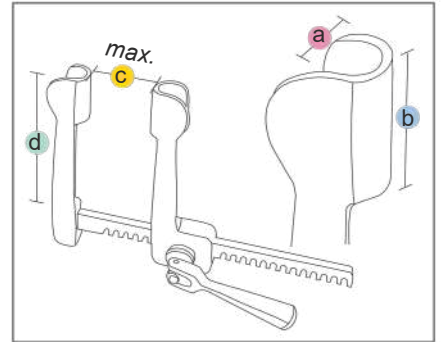

a	b	c	d	
mm	mm	mm	mm	
34	115	230	205	for adults



Cooley

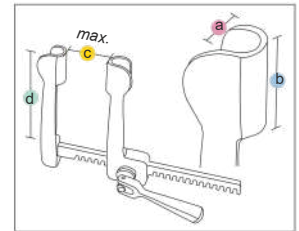

a	b	c	d	
mm	mm	mm	mm	
13	20	90	75	for children

Rib Spreaders



20 cm
Sellors



17 cm
Bailey



HARRINGTON RETRACTOR
WITH FIBER OPTIC ILLUMINATION & IRRIGATION

Retractors

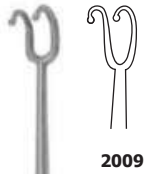

COTTLE
RETRACTOR
BLUNT

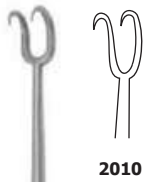

COTTLE
RETRACTOR
SHARP



COTTLE UPPER
RETRACTOR



COTTLE UPPER
TEFLON COATED RETRACTOR



ROLLET RETRACTOR
4 SHARP PRONGS



KILNER
RETRACTOR



JOSEPH
RETRACTOR
FINE SHARP



GILLIES
SKIN HOOK



Retractors



DAVIS MALLEABLE RETRACTOR

SIZE
6MM
8MM
10MM
12MM
14MM

SIZE
16MM
18MM
20MM
22MM
25MM



CZERNY RETRACTOR

6"
8"



ROUX RETRACTOR
SET OF 2



CONE SELF
RETAINING RETRACTOR

2x2
2x3
3x3
3x4



CONE SELF
RETAINING ADJUSTABLE
RETRACTOR 4 x3

6" Blunt
8" Sharp
8" Blunt



GELPI SKIN
RETRACTOR

LENGTH
18.5cm
14cm
12cm

Retractors



18x5mm
25x7mm
35x10mm
42x10mm
55x12mm
70x14mm
80x16mm

OBWEGESER
RETRACTOR
DOWN



25cmx6mm
35x10mm
42x10mm
55x12mm
70x14mm
80x16mm

OBWEGESER
RETRACTOR
UP



SMALL
25cmx6mm
35cmx15mm

LARGE
45cmx20mm
65cmx25mm
75cmx25mm
90cmx25mm

LANGENBECK
RETRACTOR



Adult 1½" x 12"
1" x 12"
1" x 16"

DEAVERS RETRACTOR WITH
FIBER OPTIC LIGHT CARRIERS

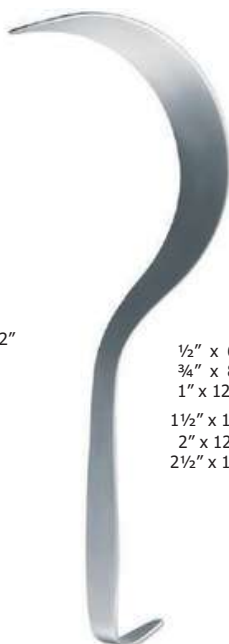

½" x 6"
¾" x 8"
1" x 12"
1½" x 12"
2" x 12"
2½" x 12"

DEAVERS RETRACTOR



25,5 cm – 10
Ross



#1



#2

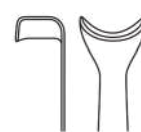

#3



#4

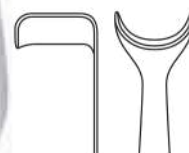

#5

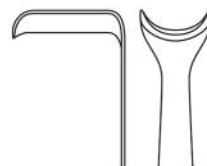

#6

Atrium Retractor

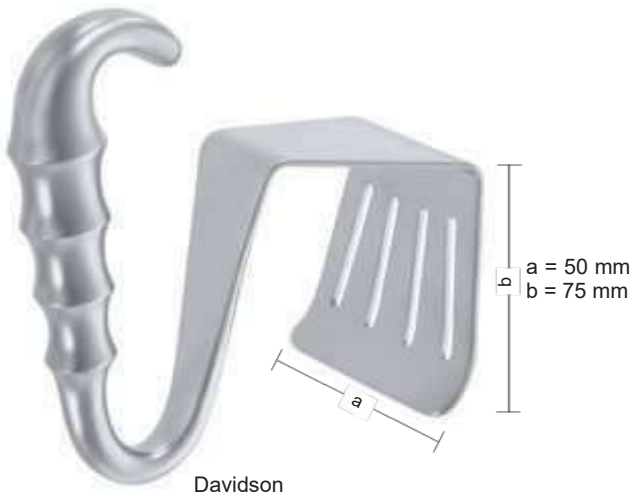
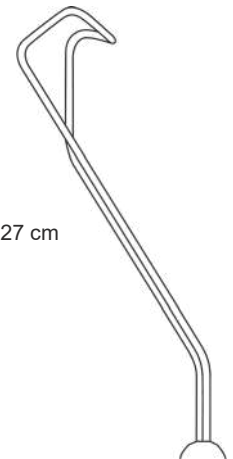
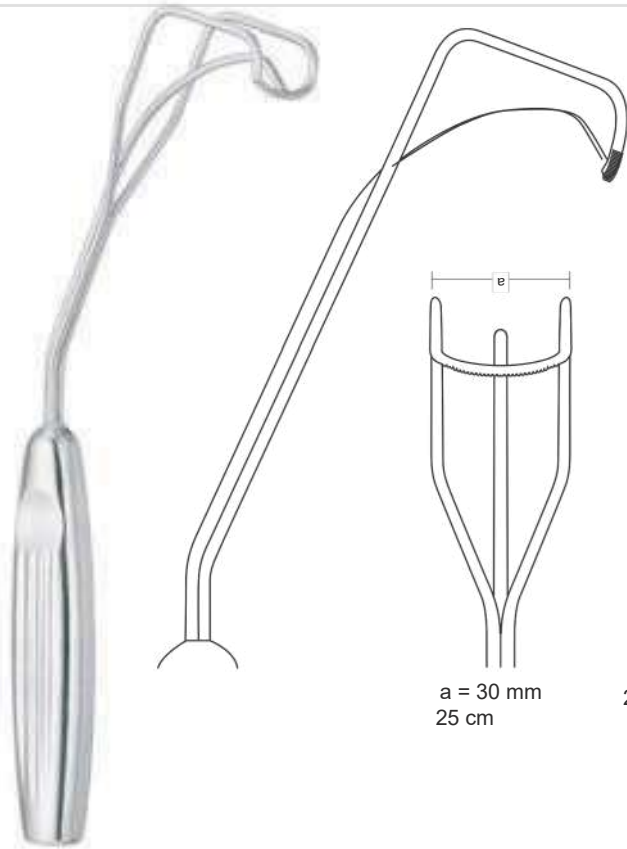

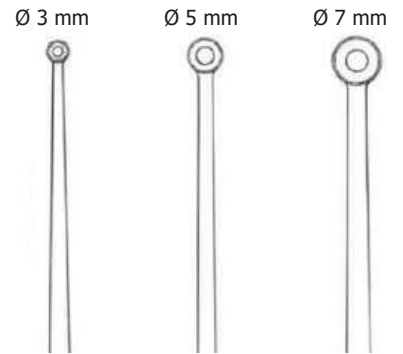
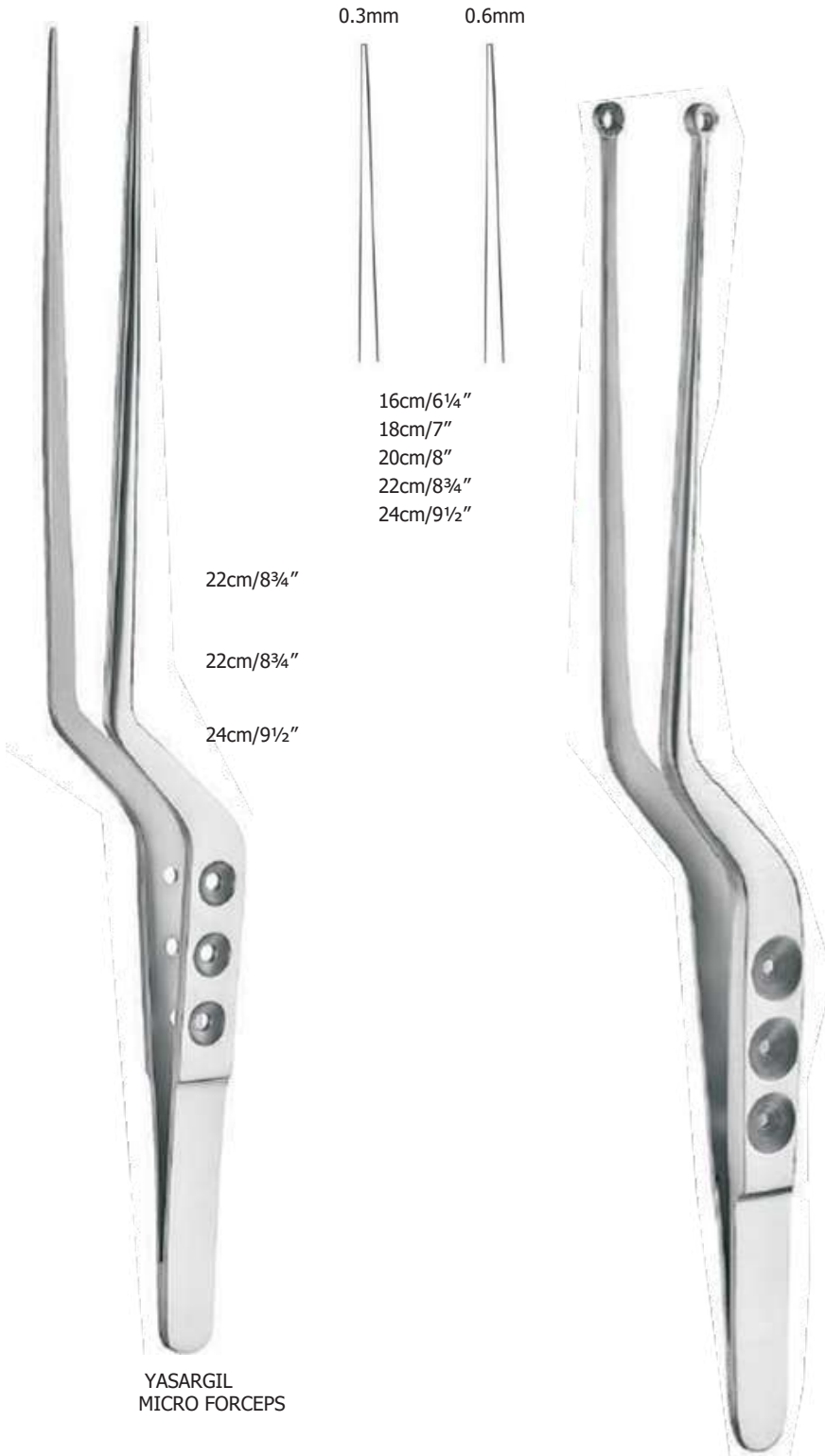

JAW SPOON SHAPED

22cm/8¾"
24cm/9½"

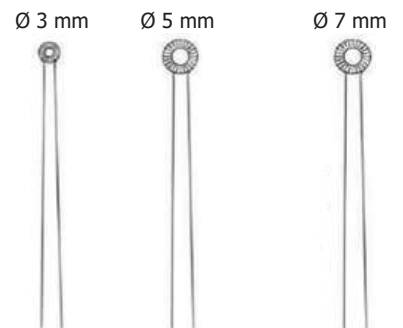

SERRATED FLAT JAW 22cm/8¾"

TOOTH CURETTE JAW- 22cm/8¾"

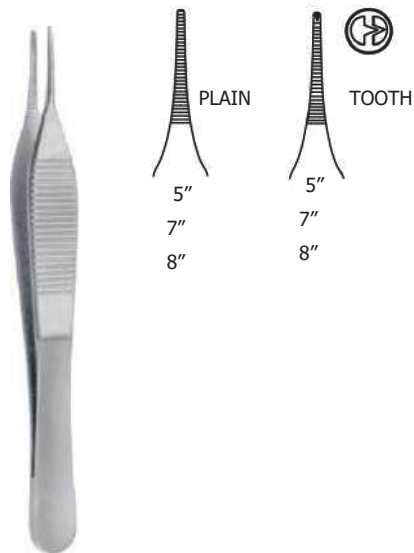

ADSON FORCEPS

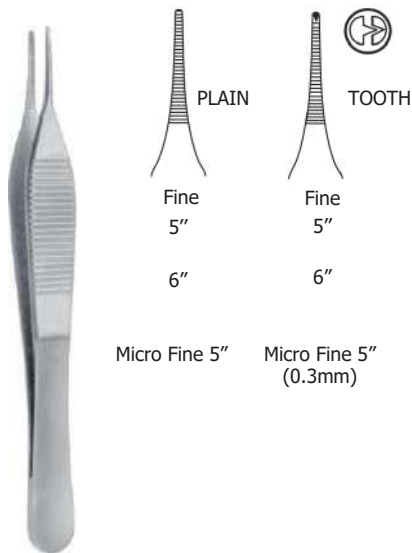

ADSON FORCEPS

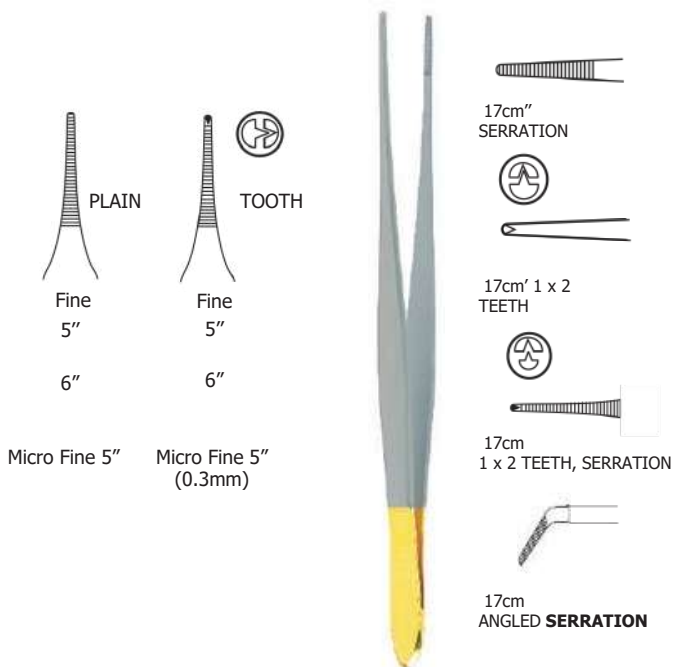

CUSHING FORCEPS SEMI SHARP
DISSECTING END GUTSCH HANDLE

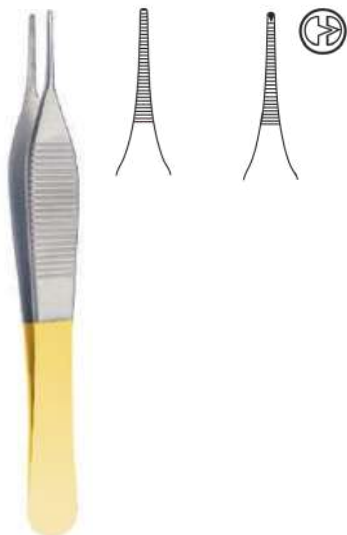

ADSON FORCEPS
PLAIN- 5"
Fine

T.C



ADSON FORCEPS
PLAIN- 5"
Fine

TITANIUM



ADSON BROWN
FORCEPS 5"



BROWN FORCEPS
8 x 8 TEETH

Micro Forceps

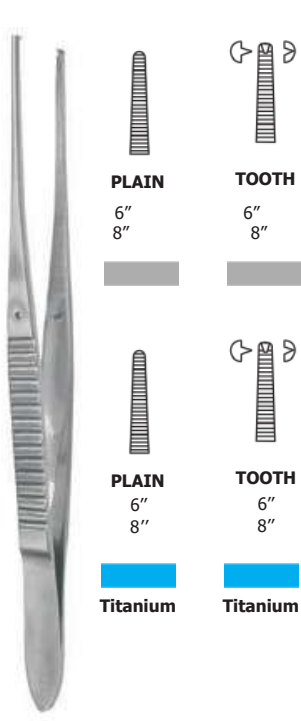

PLAIN
6"
8"

TOOTH
6"
8"

PLAIN
6"
8"

TOOTH
6"
8"

Titanium

Titanium

DISSECTION FORCEPS
FINE

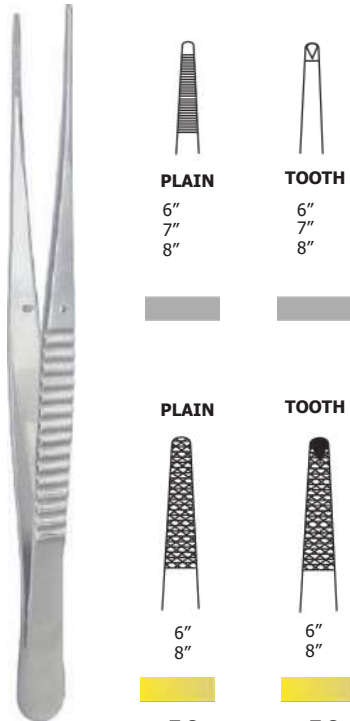

PLAIN
6"
7"
8"

TOOTH
6"
7"
8"

PLAIN

TOOTH

6"
8"

6"
8"

T.C

T.C

DISSECTING FORCEPS



CROW INSULATED FORCEPS
9" STRAIGHT

MAXWELL FORCEPS
9" CURVED

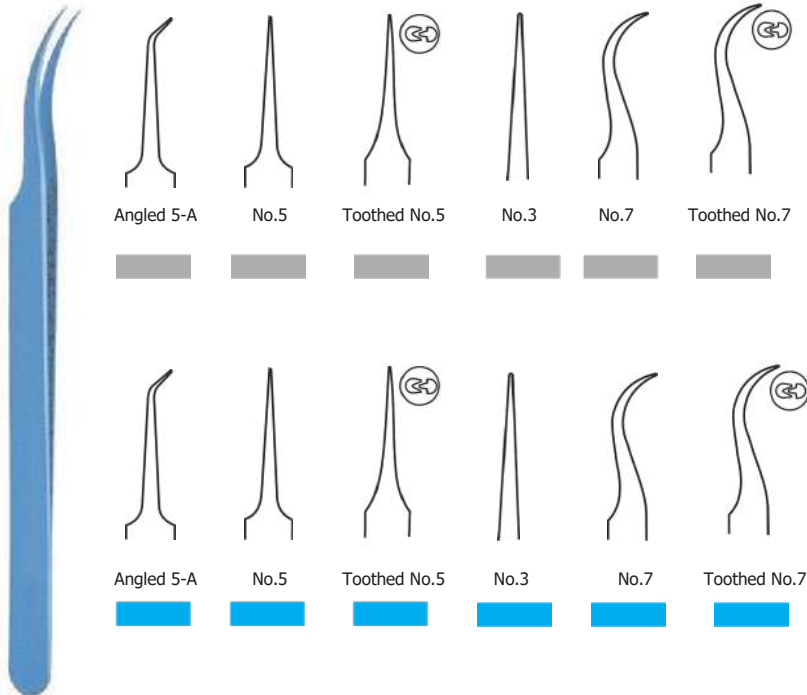

Angled 5-A

No.5

Toothed No.5

No.3

No.7

Toothed No.7

Angled 5-A

No.5

Toothed No.5

No.3

No.7

Toothed No.7

7 1/2"

GERALD FORCEPS
STRAIGHT NARROW 1 X2 TEETH

MICRO JEWELLER FORCEPS

Micro Forceps

Micro Forceps Straight (Vessel Dilators)

**11 cm Long , Flat Handle 9mm wide
Angulated 10° Tip- 0.30**



Micro Forceps Straight (Vessel Dilators)

**13.5 cm Long , Flat Handle 9mm wide
Tip- 0.30**



Micro Forceps Angled 45° (Vessel Dilators)

**13.5 cm Long , Flat Handle 9mm wide
Angulated 45° Tip- 0.30**



Micro Forceps Straight (Vessel Dilators)

**18 cm Long , Flat Handle 9mm wide
Tip- 0.30**



Micro Forceps Straight (Vessel Dilators)

**15 cm Long , Round Handle
8mm Dia**

**18 cm Long , Round Handle
8mm Dia**



Micro Forceps

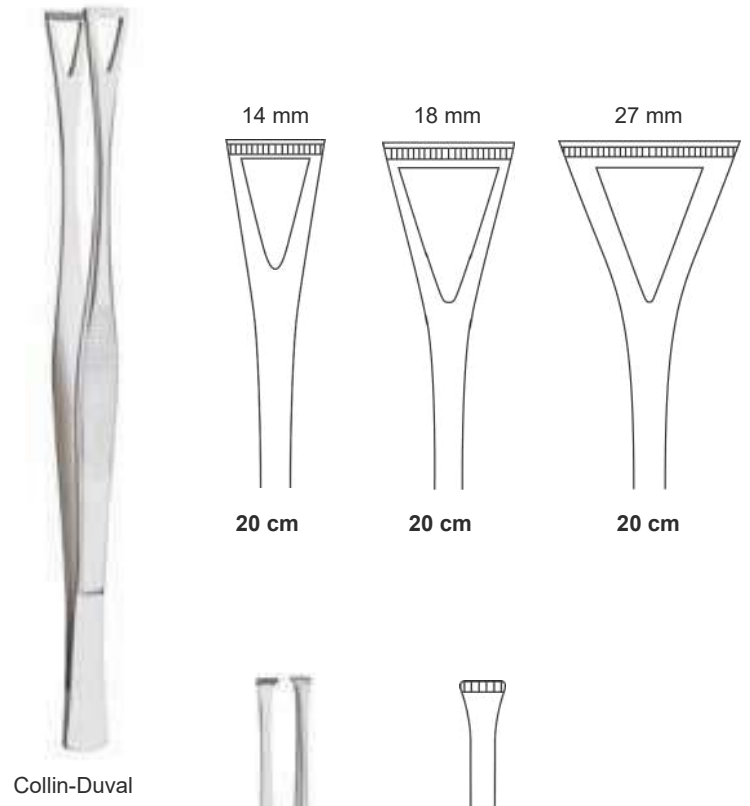
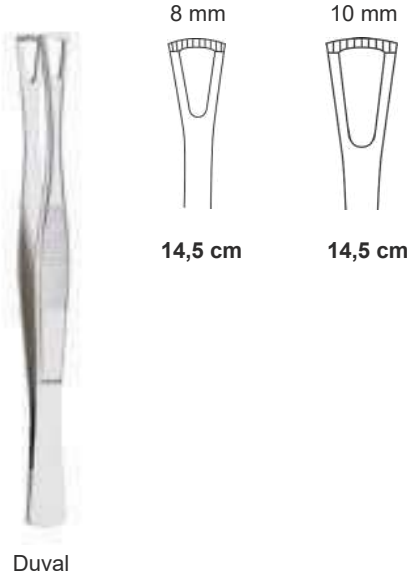



STRAIGHT		ANGLED		STRAIGHT TEETH		ANGLED TEETH	
6"	6"	6"	6"	6"	6"	6"	6"
8"	8"	8"	8"	8"	8"	8"	8"
S.S		S.S		S.S		S.S	
6"	6"	6"	6"	6"	6"	6"	6"
8"	8"	8"	8"	8"	8"	8"	8"
TITANIUM		TITANIUM		TITANIUM		TITANIUM	
6"	6"	6"	6"	6"	6"	6"	6"
8"	8"	8"	8"	8"	8"	8"	8"



STRAIGHT		ANGLED		STRAIGHT TEETH		ANGLED TEETH	
6"	6"	6"	6"	6"	6"	6"	6"
8"	8"	8"	8"	8"	8"	8"	8"
S.S		S.S		S.S		S.S	
6"	6"	6"	6"	6"	6"	6"	6"
8"	8"	8"	8"	8"	8"	8"	8"
TITANIUM		TITANIUM		TITANIUM		TITANIUM	
6"	6"	6"	6"	6"	6"	6"	6"
8"	8"	8"	8"	8"	8"	8"	8"

Micro Forceps Round Handle

Plain Micro Forceps Flat Handle



STRAIGHT		ANGLED	
1.5 mm	2 mm	1.5 mm	2 mm
S.S	S.S	S.S	S.S
6"	6"	6"	6"
7"	7"	7"	7"
8"	8"	8"	8"
	9 1/2"		9 1/2"



0.8 x 0.4mm	1 x 0.5 mm
7"	7"
8"	8"
S.S	
7"	
8"	
TITANIUM	

Debakey Vascular Forceps

Micro Forceps Round Handle

Bulldog Clamps

Debakey Bulldog Clamps



Overall Length	80mm	90mm	105mm	125mm	75mm	85mm	95mm	115mm
Jaw Length	20mm	30mm	45mm	68mm	20mm	30mm	45mm	68mm

STRAIGHT

CURVED

Debakey Bulldog Clamps Titanium

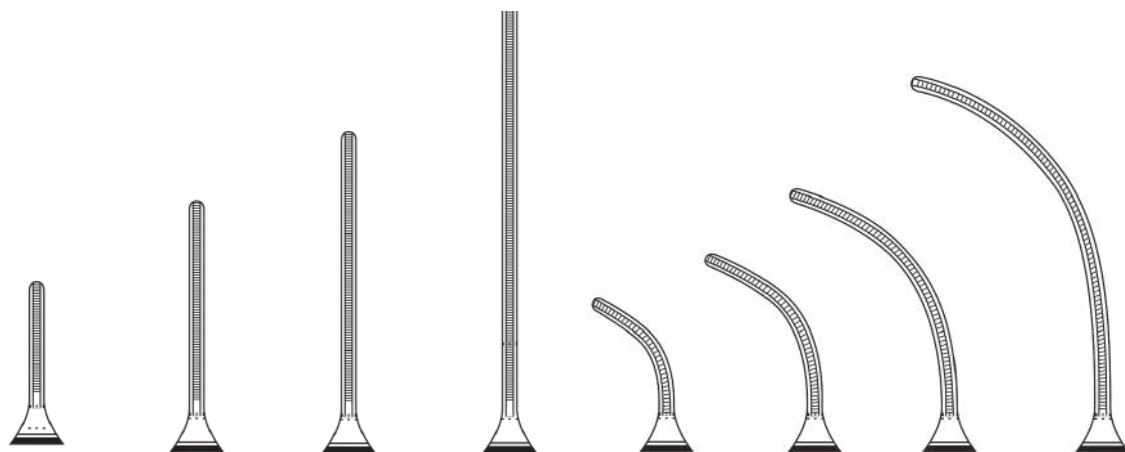

Overall Length	80mm	90mm	105mm	125mm	75mm	85mm	95mm	115mm
Jaw Length	20mm	30mm	45mm	68mm	20mm	30mm	45mm	68mm

STRAIGHT

CURVED

Bulldog Clamps

Mini Bulldog Clamps

Weight 3gr
Closing Pressure 80gr



Straight
Overall Length
Jaw Length



50mm	55mm	60mm	65mm
8mm	12mm	16mm	20mm

Curved
Overall Length
Jaw Length

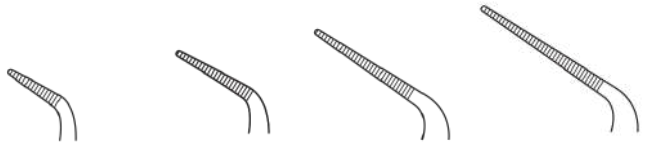

43mm	45mm	50mm	55mm
8mm	12mm	16mm	20mm

Debakey Diethrich Mini Bulldog Clamps

Weight 3gr
Closing pressure 180gr



Overall Length
Jaw Length



47mm	51mm	57mm
10mm	14mm	20mm

Overall Length
Jaw Length



44mm	46mm	49mm
10mm	14mm	20mm

Mini Glover Bulldog Clamps

Straight
Weight 0.8gr



Overall Length
Jaw Length

30mm
11mm

35mm
15mm

40mm
17mm

55mm
24mm

Mini Glover Bulldog Clamps

Curved weight 0.8gr



Overall Length
Jaw Length

30mm
11mm

35mm
15mm

40mm
17mm

55mm
24mm

Mini Glover Bulldog Clamp
Strongly Curved Weight 0.8gr



Overall Length
Jaw Length

30mm
11mm

35mm
15mm

40mm
17mm

55mm
24mm

Bulldog Clamps

Glover Bulldog Clamps
Straight
Closing Pressure Adjustable



Overall Length
Jaw Length

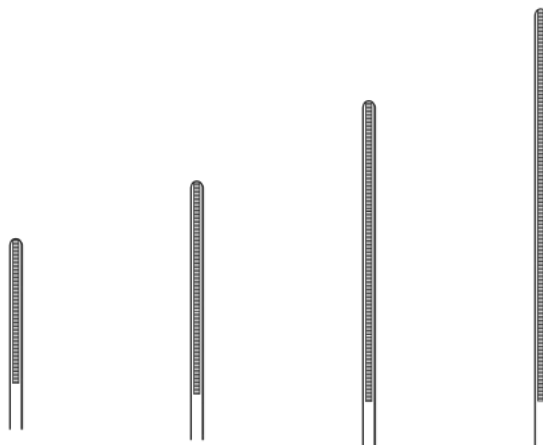

50mm	68mm	85mm	105mm
20mm	30mm	43mm	56mm

Glover Bulldog Clamps
Curved
Closing Pressure Adjustable



Overall Length
Jaw Length

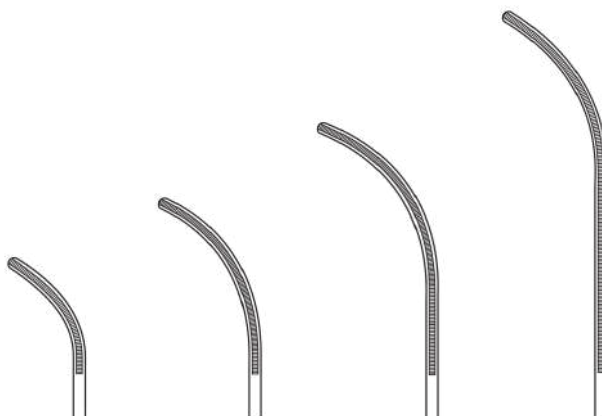

46mm	64mm	78mm	100mm
20mm	30mm	43mm	56mm

Mini-Glover Bulldog Clamps
Weight 12g



Overall Length
Jaw Length

straight

35mm
14mm

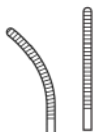

curved

35mm
14mm



full curved

35mm
14mm



angled

35mm
14mm

Bulldog Clamps

Glover Bulldog Clamps
Angled
55mm length jaws

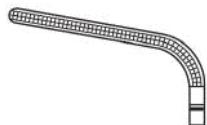

Debakay-Satinsky Bulldog Clamps
Curved
55mm length jaws

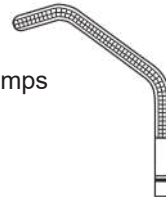

Debakay Carotid Bulldog Clamps
Curved 90mm length jaws

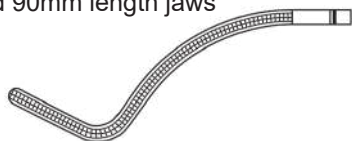

Debakay Satinsky Bulldog Clamps
Curved 100mm length jaws

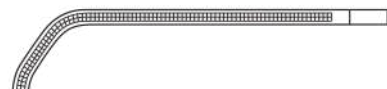

Modified Gregory Bulldog Clamps
Curved weight 12g



Overall Length 110mm, 60mm
Jaw Length Curved to Left

110mm, 60mm
Curved to Right





Micro Apply Clamps Single



Micro Apply Clamps Double



Micro Apply Clamps Double With Frame

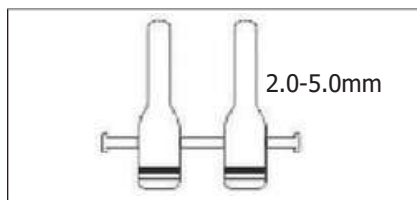
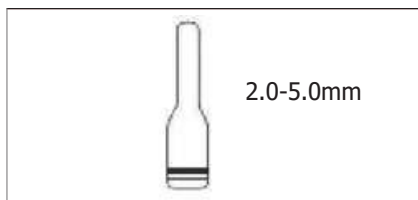
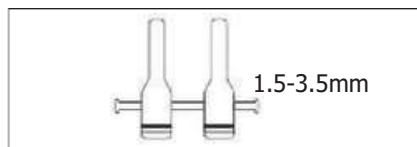
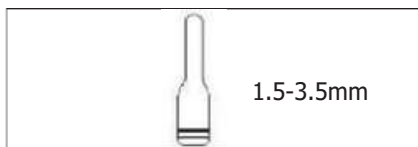
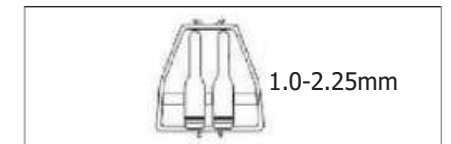
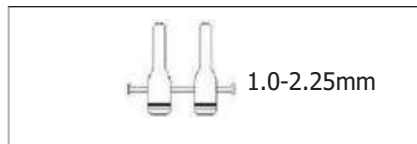
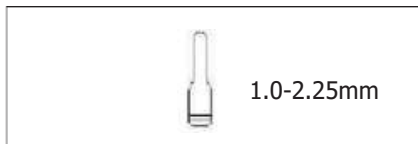
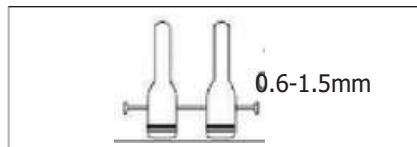
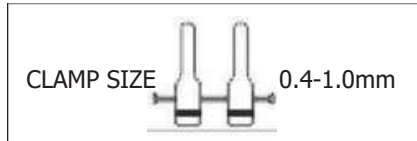
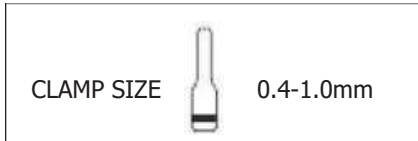

CLAMP APPLICATOR

MICRO SPRING SCISSORS FLAT HANDLE

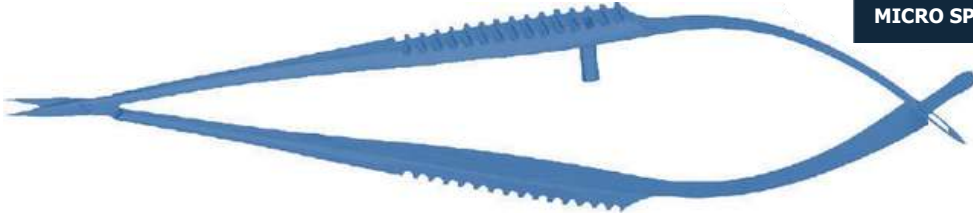

S.S
 T.C
 TITANIUM

SIZE
6"
 6"
 6"

S.S
 T.C
 TITANIUM

SIZE
7"
 7"
 7"

S.S
 T.C
 TITANIUM

SIZE
8"
 8"
 8"

MICRO SCISSORS SPRING ROUND HANDLE



S.S
 T.C
 TITANIUM

SIZE
6"
 6"
 6"
 6"

S.S
 T.C
 TITANIUM

SIZE
7"
 7"
 7"
 7"

S.S
 T.C
 TITANIUM

SIZE
8"
 8"
 8"
 8"

DENNIS MICRO SCISSORS SPRING ROUND HANDLE, DOUBLE ACTION, 18.4CM



S.S

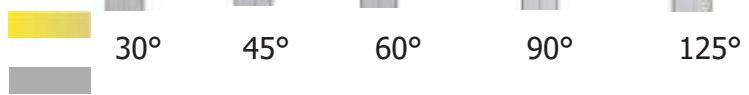
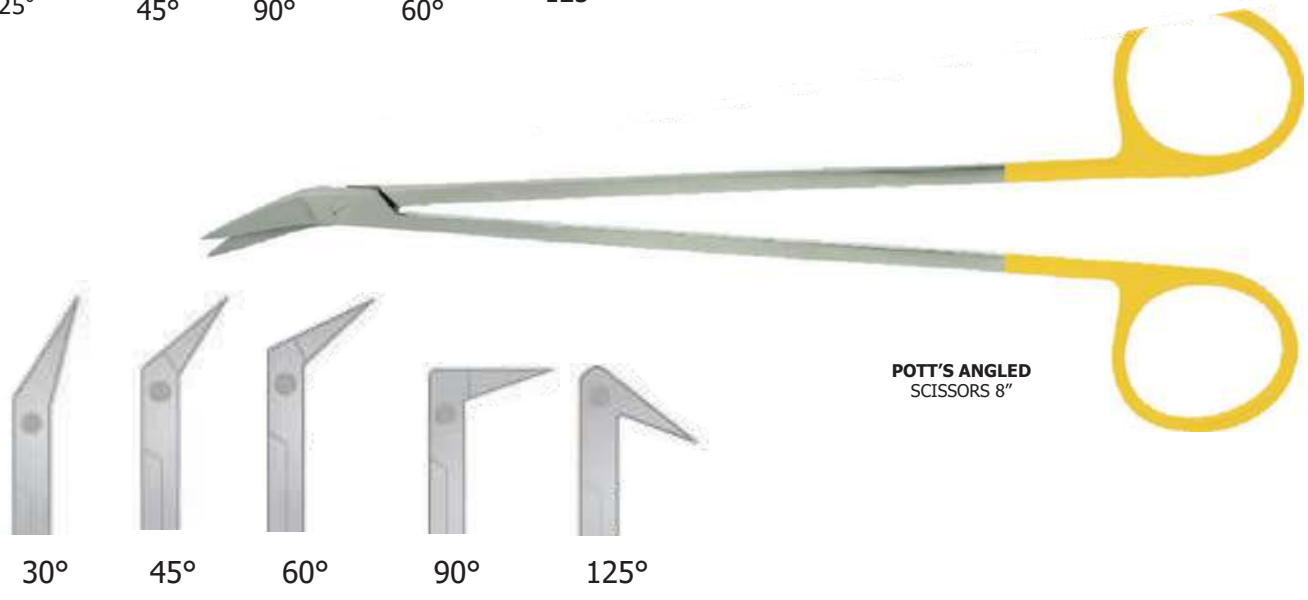
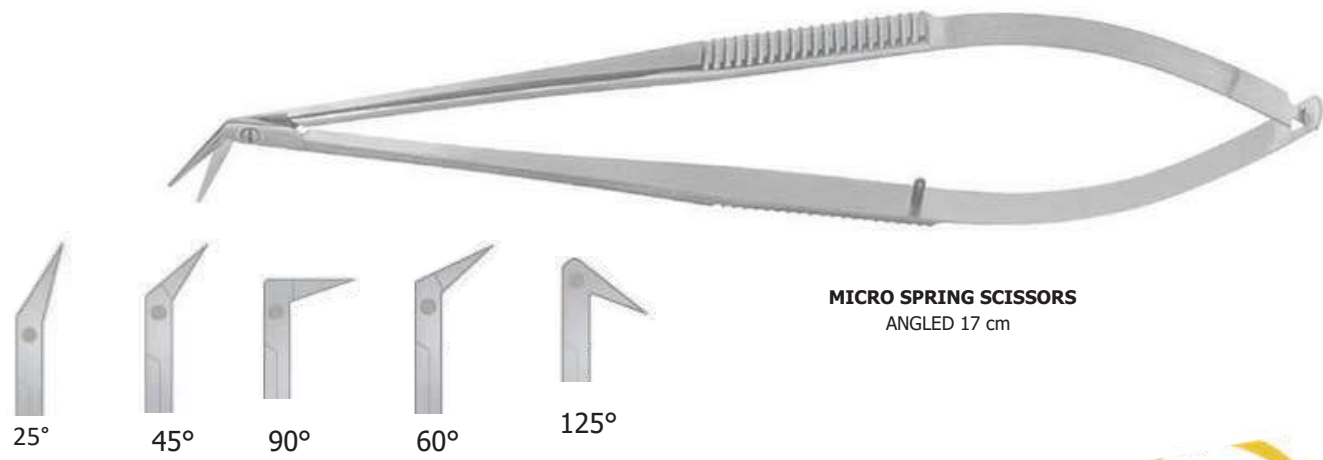
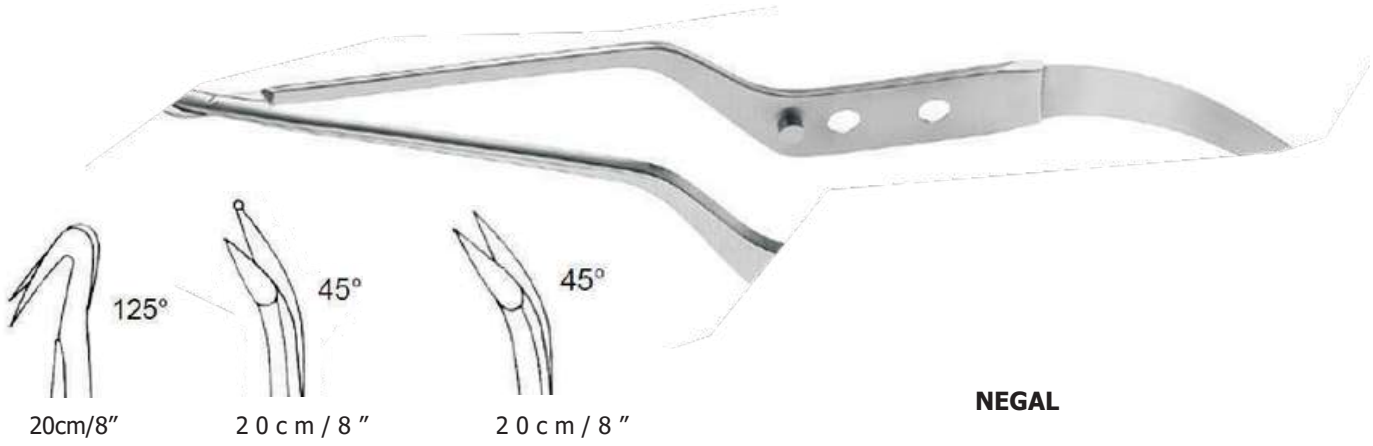

YASARGIL MICRO SCISSORS BAYONET SHAPE



YASARGIL



UPWARD
22.5cm/9"
TITANIUM



DOWNWARD
22.5cm/9"



STRAIGHT
22.5cm/9"
TITANIUM



UPWARD
22.5cm/9"
24.5cm/9¾"
22.5cm/9"
T.C



STRAIGHT
22.5CM
24.5CM
22.5CM
T.C
T.C



YASARGIL

Scissors

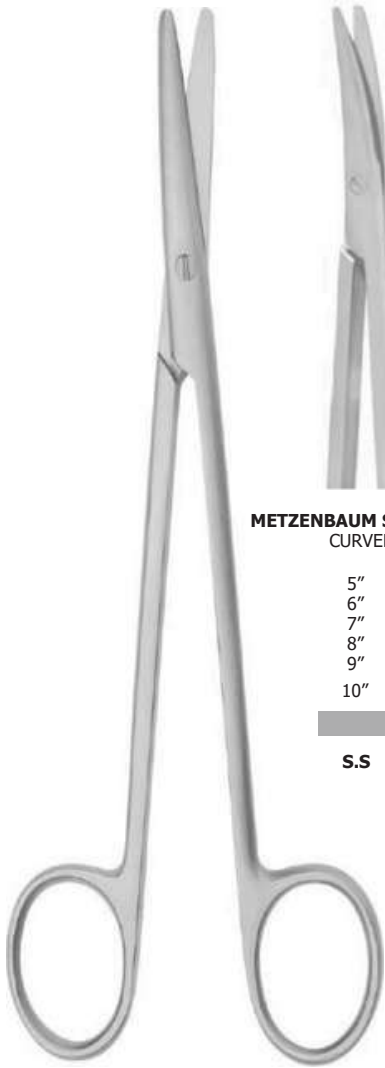

METZENBAUM SCISSORS
CURVED

- 5"
- 6"
- 7"
- 8"
- 9"
- 10"

S.S

METZENBAUM SCISSORS
STRAIGHT

- 5"
- 6"
- 7"
- 8"
- 9"
- 10"

S.S

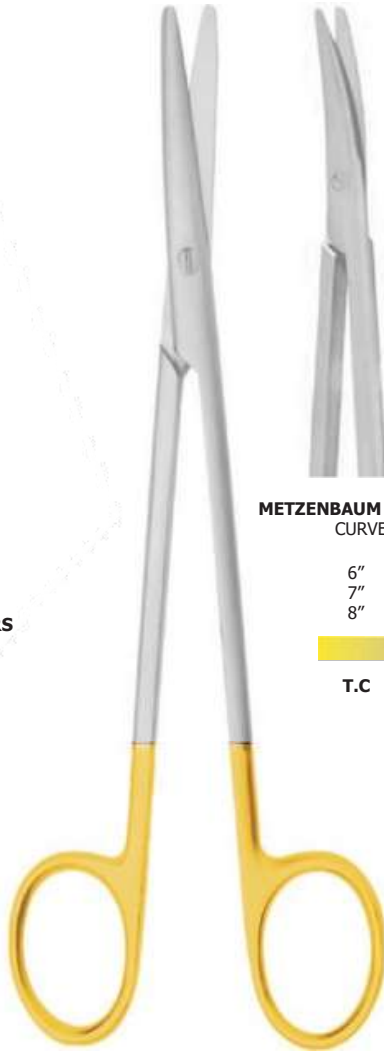

METZENBAUM SCISSORS
CURVED

- 6"
- 7"
- 8"

T.C

METZENBAUM SCISSORS
STRAIGHT

- 6"
- 7"
- 8"

T.C

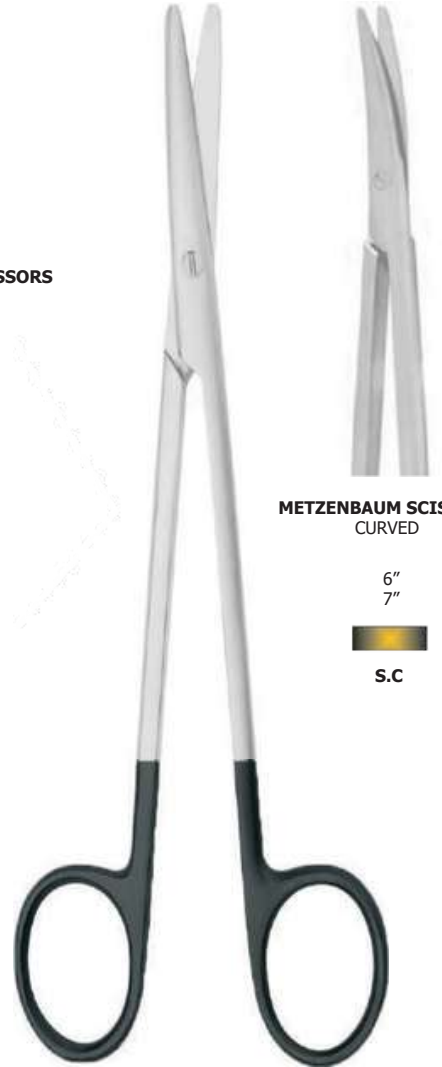

METZENBAUM SCISSORS
CURVED

- 6"
- 7"

S.C

METZENBAUM SCISSORS
STRAIGHT

- 6"
- 7"

S.C

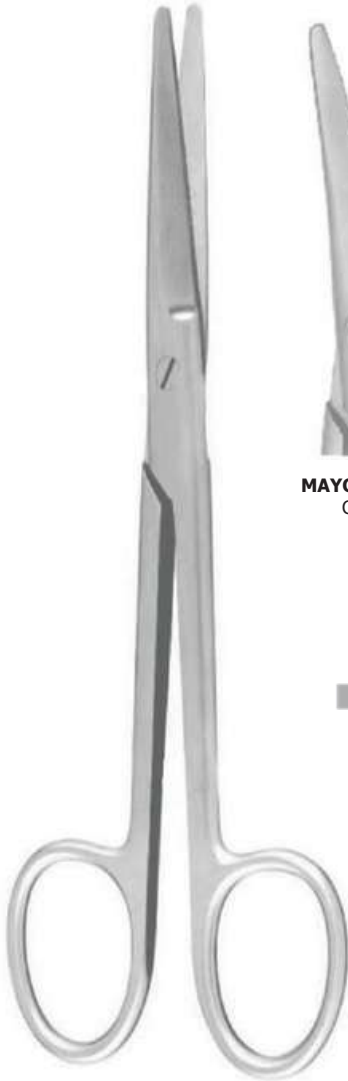

MAYO SCISSORS
STRAIGHT

- 5½"
- 6½"
- 7½"
- 8½"
- 9½"
- 10½"



S.S



MAYO SCISSORS
CURVED

- 5½"
- 6½"
- 7½"
- 8½"
- 9½"
- 10½"



S.S

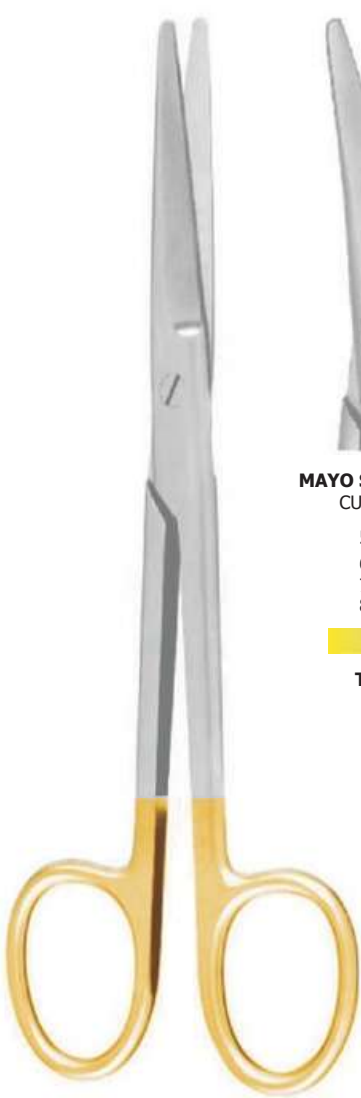

MAYO SCISSORS
STRAIGHT

- 5½"
- 6½"
- 7½"
- 8½"



T.C



MAYO SCISSORS
CURVED

- 5½"
- 6½"
- 7½"
- 8½"



T.C



MAYO SCISSORS
STRAIGHT

- 6½"
- 7½"



S.C



MAYO SCISSORS
CURVED

- 6½"
- 7½"

S.C

Scissors



STEVENS SCISSORS
STRAIGHT
4½"
S.S

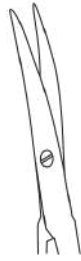

STEVENS SCISSORS
CURVED
4½"
S.S



STEVENS SCISSORS
STRAIGHT
4½"
T.C



STEVENS SCISSORS
CURVED
4½"
T.C



STEVENS SCISSORS
STRAIGHT
4½"
S.C

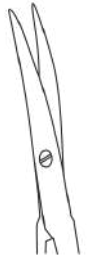

STEVENS SCISSORS
CURVED
4½"
S.C



GREEN BERG SCISSORS
STRAIGHT
5½"
S.S



GREEN BERG SCISSORS
CURVED
5½"
S.S



GREEN BERG SCISSORS
STRAIGHT
5½"
T.C



GREEN BERG SCISSORS
CURVED
5½"
T.C



GREEN BERG SCISSORS
STRAIGHT
5½"
S.C



GREEN BERG SCISSORS
CURVED
5½"
S.C

Scissors



KNAPP SCISSORS
CURVED
4 1/2"
S.S



KNAPP SCISSORS
CURVED
4 1/2"
5 1/2"
T.C



KNAPP SCISSORS
CURVED
4 1/2"
5 1/2"
S.C

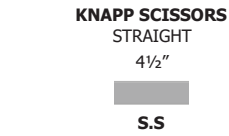

KNAPP SCISSORS
STRAIGHT
4 1/2"
S.S

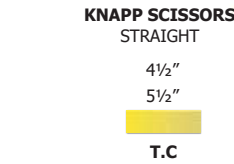

KNAPP SCISSORS
STRAIGHT
4 1/2"
5 1/2"
T.C

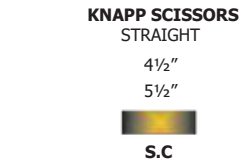

KNAPP SCISSORS
STRAIGHT
4 1/2"
5 1/2"
S.C



IRIS SCISSORS
CURVED
3 1/2"
4"
5"
S.S



IRIS SCISSORS
CURVED
3 1/2"
4"
5"
T.C



IRIS SCISSORS
CURVED
4"
5"
S.C

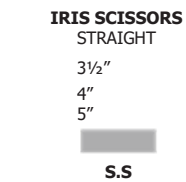

IRIS SCISSORS
STRAIGHT
3 1/2"
4"
5"
S.S

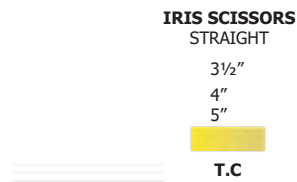

IRIS SCISSORS
STRAIGHT
3 1/2"
4"
5"
T.C

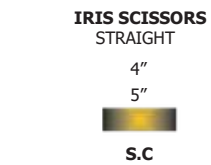

IRIS SCISSORS
STRAIGHT
4"
5"
S.C

Scissors

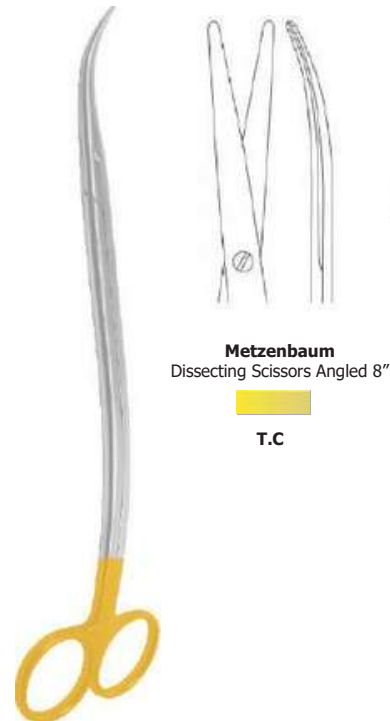
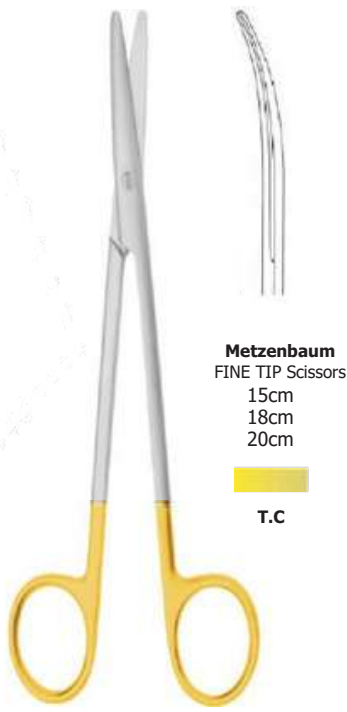

Needle Holders

YASARGIL MICRO NEEDLE HOLDER BAYONET SHAPE



YASARGIL

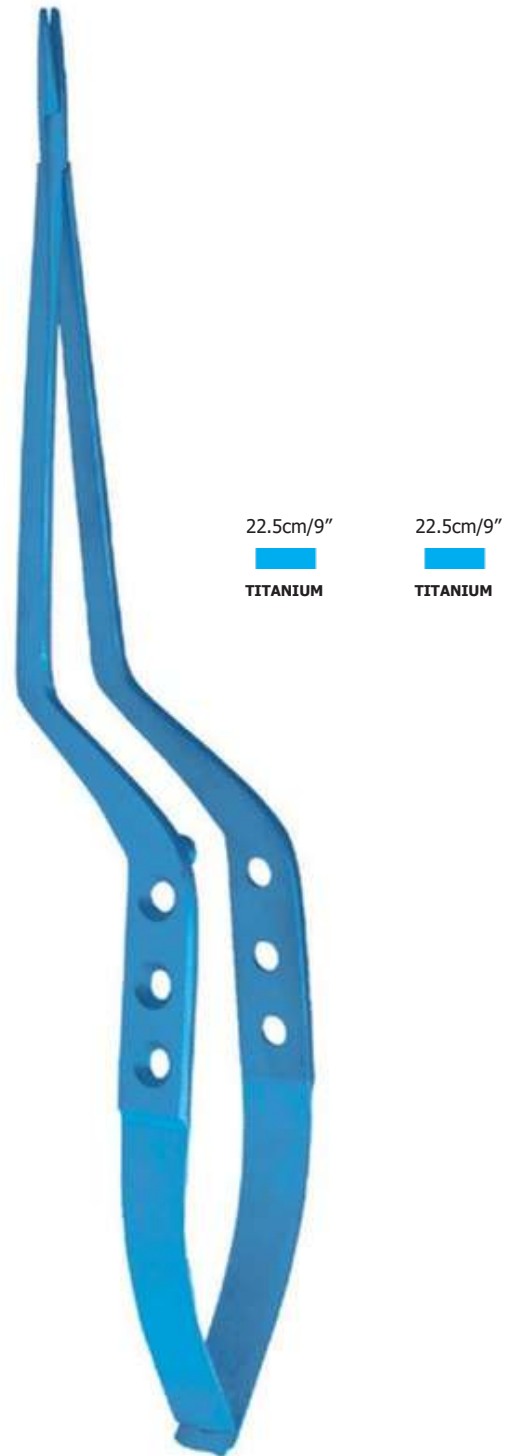

YASARGIL

Needle Holders

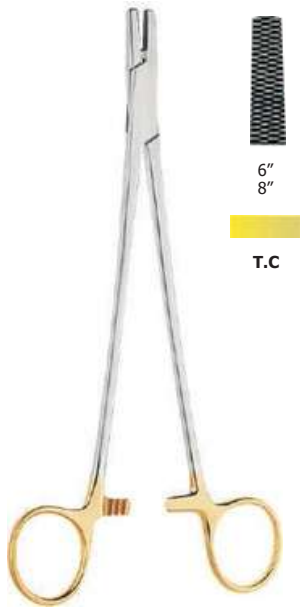

6"
8"

T.C

WIRE TWISTER

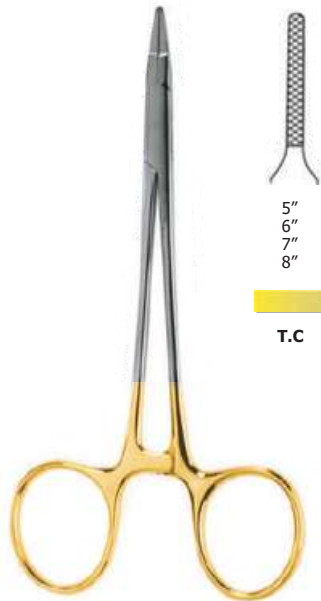

5"
6"
7"
8"

T.C

RYDER NEEDLE HOLDER

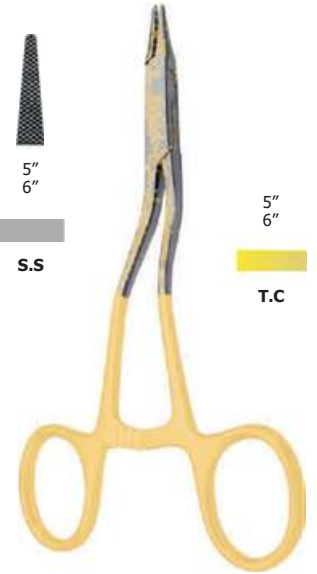

5"
6"

S.S

5"
6"

T.C

KILNER NEEDLE HOLDER

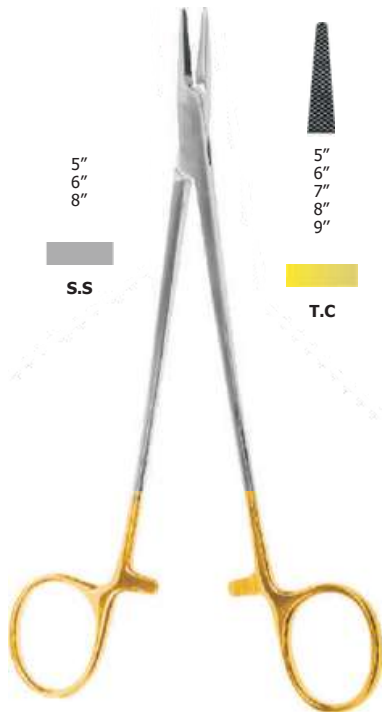

5"
6"
8"

S.S

5"
6"
7"
8"
9"

T.C

**MICRO VASCULAR NEEDLE
HOLDER**



5"
6"

Titanium

**MICRO VASCULAR NEEDLE
HOLDER**

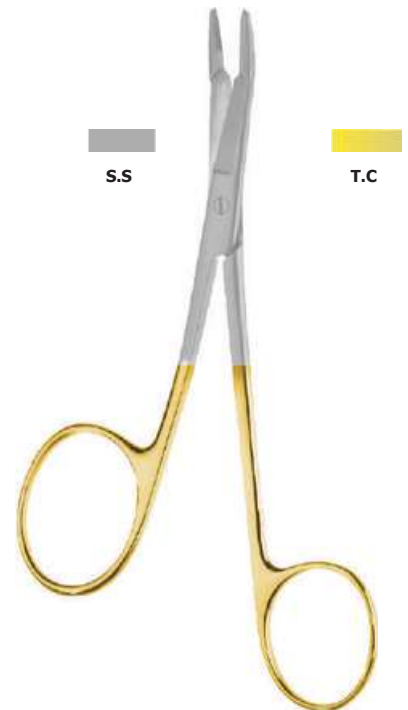

S.S

T.C

OLSEN HAGAR NEEDLE HOLDER

Needle Holders

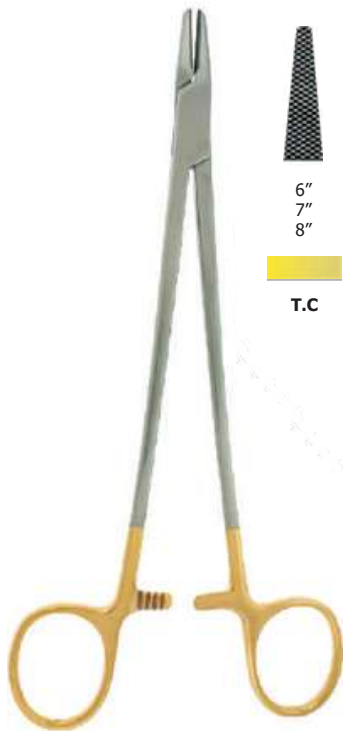

6"
7"
8"



T.C

MAYO HEGAR NEEDLE HOLDER

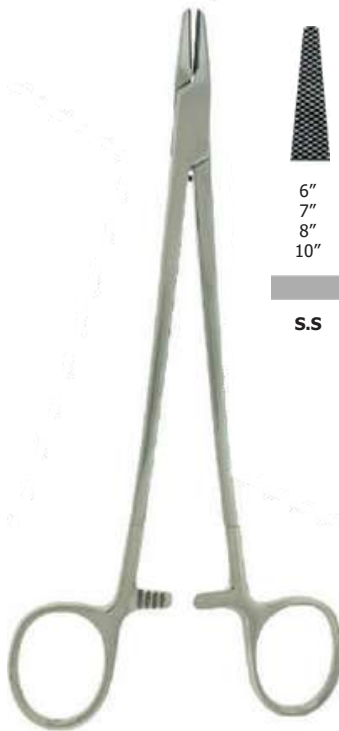

6"
7"
8"
10"



S.S

MAYO HEGAR NEEDLE HOLDER

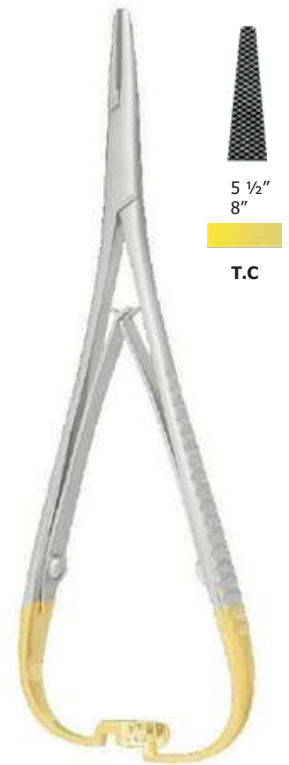

5 1/2"
8"



T.C

MATHIEU NEEDLE HOLDER

FINE MICRO SPRING NEEDLE HOLDER FLAT HANDLE



Needle Holders

MICRO SPRING NEEDLE HOLDER FLAT HANDLE

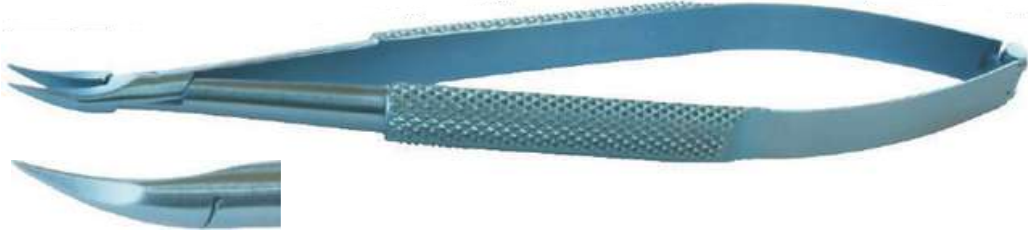

Elevators/Dissectors



COTTLE MCKENTY
ELEVATOR



COHEN
ELEVATOR



DISSECTOR
WITH SUCCER



RIGHT **LEFT**
DOYEN RIB RASPATORY



FREER
ELEVATOR BROAD



FREER
ELEVATOR FINE



FREER
ELEVATOR



MASING
ELEVATOR GRADUATED



HOWARTH
ELEVATOR

Elevators/Dissectors

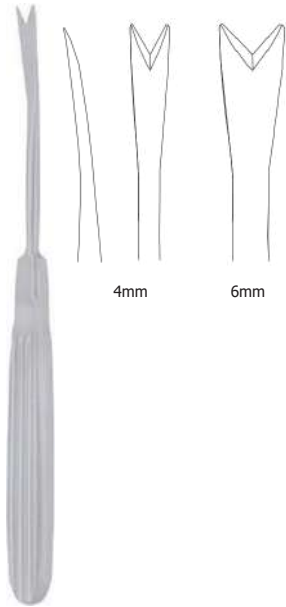

OBWEGESER V
RASPATORIEN

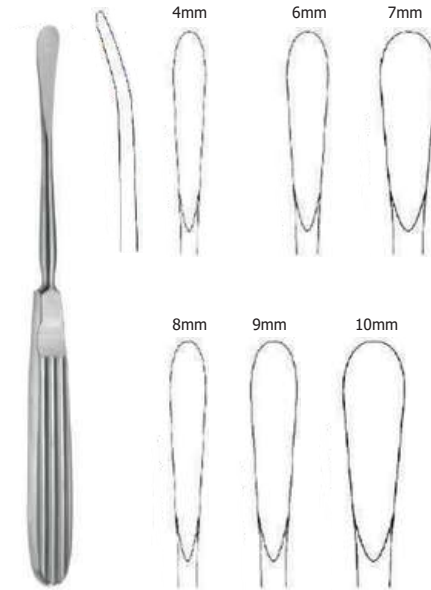

RASPATORIEN
ROUND

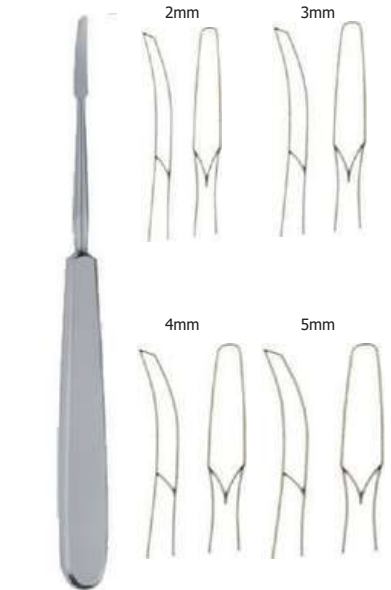

RASPATORIEN
SHARP



MALLEABLE
SUCTION

MALLEABLE
PROBE



WILLIGER
RASPATORIEN

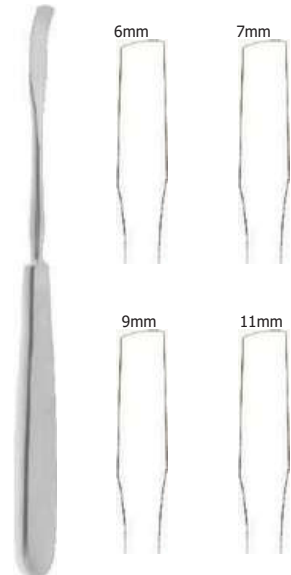

OBWEGESER
RASPATORIEN

Elevators/Dissectors



CRILE NERVE HOOK BLUNT
90° ANGLED HOOK DEPTH-5mm
TIP DIAMETER-1.25mm

23cm/9"
FIG.1

TITANIUM



CUSHING
NERVE HOOK 90° ANGLED

FIG.1
HOOK
DEPTH-3mm
TIP DIA-1mm
19cm/7½"
TITANIUM
19cm/7½"

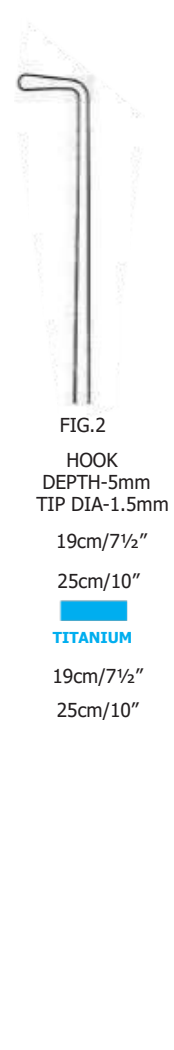

DANDAY NERVE
HOOK BLUNT
HOOK DEPTH-3mm
TIP DIA-1.5mm
23cm/9"

FIG.2
HOOK
DEPTH-5mm
TIP DIA-1.5mm
19cm/7½"
25cm/10"
TITANIUM
19cm/7½"
25cm/10"



BLUNT
90° ANGLED
TITANIUM



BLUNT
45° ANGLED
TITANIUM



NERVE HOOK STRAIGHT
ROUND TIP MALLEABLE
TIP DIA-2mm LENGTH-
23cm/9"

Elevators/Dissectors



ADSON RECTANGULAR NERVE &
DURA HOOK LENGTH: 19cm/ 7½"



SHARP

TITANIUM



BLUNT

TITANIUM



KRAYENBÜHL
NERVE & VESSEL HOOK
18.5cm/7¼"

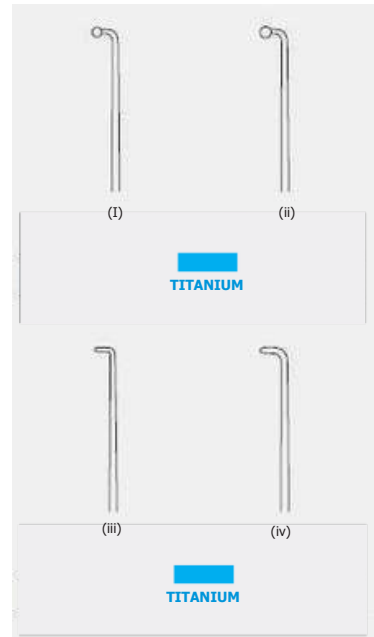

Elevators/Dissectors



RHOTON TYPE
DISSECTORS
7 1/2"



No.1

No.2

No.3

No.4

No.5

STAINLESS STEEL
TITANIUM

SMALL
1.5mm
DISSECTORS

MEDIUM
2.0mm

BLADE
3.0mm

CURVED
ELEVATORS

ANGLED



No.6

No.7

No.8

No.9

No.10

STAINLESS STEEL
TITANIUM

SMALL
2.0mm

MEDIUM
3.0mm

LARGE
2.0mm

NEUTRAL

100.0mm



No.11

No.12

No.13

No.14

No.15

No.16

DISSECTOR
2.0mm



No.17

No.18

No.19

Endarterectomy Instruments



55 cm – 21 $\frac{3}{4}$ "

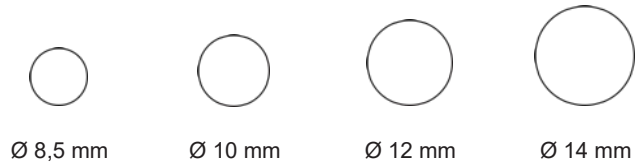

Handle for endarterectomy strippers



12 cm – 4 $\frac{3}{8}$ "

MICRO SUCTION CANNULA ATRAUMATIC & RIGID SUCTION CANNULA WITH KEY HOLE

THE BALL TIP AT THE END OF THE INSTRUMENT ALLOWS GENTLE PREPARATION & STABLE ATRAUMATIC RETRACTION.

WORKING LENGTH
140mm



1.4mm 4 FR

2.0mm 6 FR

2.7mm 8 FR



SUCTION CANNULAS WITH KEY HOLE

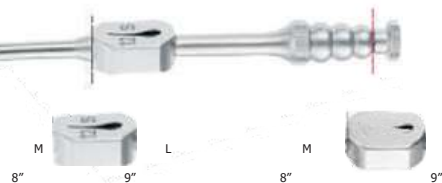

TOTAL LENGTH

4 FR \varnothing 2.0mm

6 FR \varnothing 2.7mm

8 FR \varnothing 3.3mm

10 FR \varnothing 4.0mm

12 FR \varnothing 4.5mm

SUCTION CANNULAS CURVED SUCTION INSTRUMENTS



WORKING LENGTH 135mm, 5 1/4"

WORKING LENGTH
TOTAL LENGTH
OUTER DIAMETER
INNER DIAMETER
ANGLED TIP

135mm 5 1/4"
200mm 8" 2.7mm
2.0mm RIGHT
ANGLED TIP

135mm 5 1/4"
200mm 8" 2.7mm
2.0mm LEFT
ANGLED TIP

Suction Tubes & Cannula

Frazier Suction Tube
Angled 90°

Overall Length

Diameter Ø 17cm/6½"

2.0mm
2.7mm
3.3mm
4.0mm
4.7mm



Frazier Suction Tube
30cm/11½" Length

Adult size for 9.5mm/3/8" Tubing

Child size for 6mm/1/4" Tubing



Brompton Hospital Suction Tube
Paediatric 4.8mm Ø size
23cm/9" Length
For 6.5mm/1/4" Tubing



Southampton Western Hospital Suction Tube

23cm/9" Length
Paediatric 3.3mm 1/3" Ø
For 6.5mm/ 1/4" Tubing



Vascular Suction Tube with
Removable Basket 28cm/11" Length



Suction Tubes & Cannula

Tibbs Arterial Cannula
Long Pattern Luer Lock

Set of 4
Large Cone
Small Cone
Large Olive
Small Olive

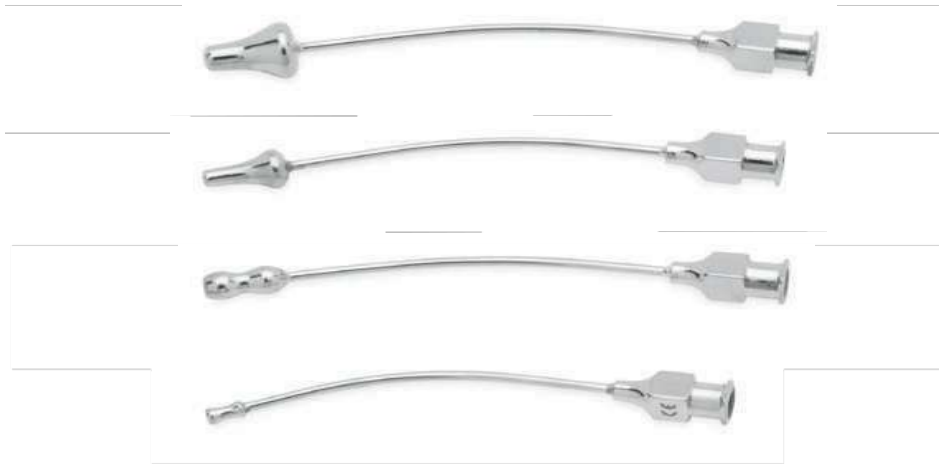

Heparin Flushing Needle
Luer Lock

2mm Ø Tip
2.5mm Ø Tip
3mm Ø Tip



Magill Suction Tube
21cm/ 8 1/4" Length

3mm Ø Tip
3.5mm Ø Tip
4mm Ø Tip



Yankauer Suction Tube
30.5cm/12" Length



Pooles Suction Tube
24cm/9 1/2" Length 10mm Ø

Curved Mount



Paediatric Pooles Suction Tube
15cm/6" Length 6mm Ø

Straight Mount illustrated
Curved Mount



Perfusion Cannula

Ross Atrial Basket



length	tubing size Ø
29mm	1/2"/12.7mm
29mm	3/8"/9.5mm
19mm	3/8"/9.5mm
16mm	1/4"/6.3mm

Ross Sump Sucker (screw apart)



	diameter	tubing size Ø
Adult	7.5mm	3/16"/5.0mm
Child	6.5mm	3/16"/5.0mm
Infant	5.0mm	1/8"/3.5mm

Ross Ventricular Vent (screw apart)



	diameter	tubing size Ø
Adult	7.5mm	3/16"/5.0mm
Child	6.5mm	3/16"/5.0mm
Infant	5.0mm	1/8"/3.5mm

Baylor Sump Sucker (screw apart)



outside diameter
4.0mm
5.0mm
6.0mm

Bentall Femoral Cannula

- Rolled edge to bevel



bore Ø	bore Ø
1.5mm	4.5mm
2.0mm	5.0mm
2.5mm	5.5mm
3.0mm	6.0mm
3.5mm	6.5mm
4.0mm	7.0mm

Iliac Cannula

- Angled



bore Ø	bore Ø
2.5mm	4.5mm
3.0mm	5.0mm
3.5mm	5.5mm
4.0mm	6.0mm

JS Venous Cannula

- Cage tip
- 80° angled
- Long tubing end



bore Ø	bore Ø
3mm	6mm
4mm	7mm
5mm	8mm

Lung Spatulas

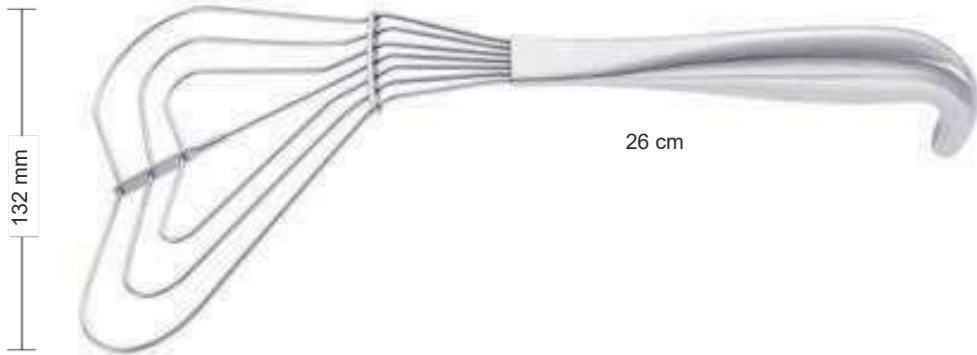
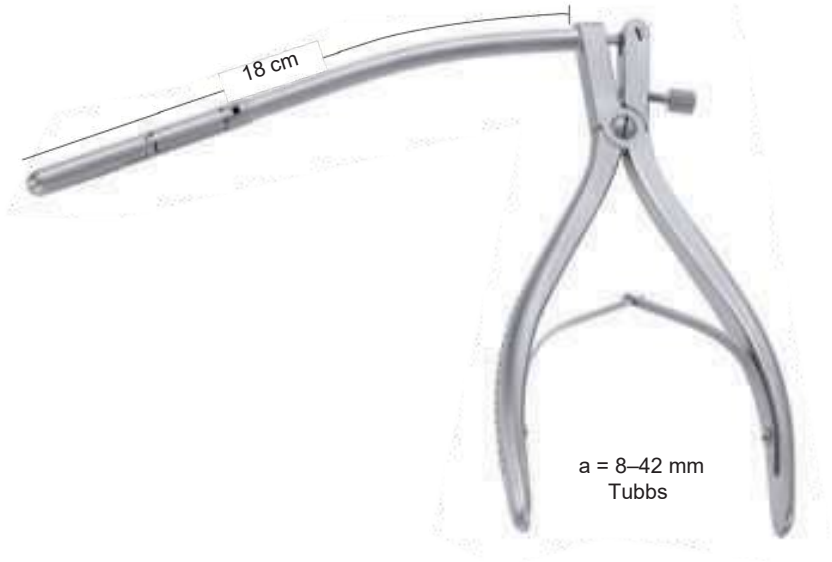

27 cm
a = 40 mm
Allison

32 cm
a = 65 mm
Allison



Rumel-Belmont

Vessel Dilators & Probes

Ross Coronary Artery Probe
Same thickness along length of shaft

Diameter Ø15cm length

- 0.5mm
- 1.0mm
- 1.5mm
- 2.0mm
- 2.5mm
- 3.0mm



DeBakey Vessel Dilator
19cm/ 7 1/2" Length
Malleable Shaft

Diameter Ø

Diameter Ø

- | | |
|-------|-------|
| 0.5mm | 3.5mm |
| 1.0mm | 4.0mm |
| 1.5mm | 4.5mm |
| 2.0mm | 5.0mm |
| 2.5mm | 7.0mm |
| 3.0mm | 9.0mm |



Garrett Vessel Dilator
Malleable Shaft

Diameter Ø 21cm Length

- 1.0mm
- 1.5mm
- 2.0mm
- 2.5mm
- 3.0mm
- 3.5mm
- 4.0mm
- 4.5mm
- 5.0mm



Blades & Handle



B.P. Handle 3
LONG HANDLE
B.P. Handle 3



B.P. Handle 4
LONG HANDLE
B.P. Handle 4



B.P. Handle 7



ROUND. Handle 3



B.P. Handle Curved



VERTICAL CUTTING NO-3
HORIZONTAL CUTTING NO-3
VERTICAL CUTTING NO-4



ROUND HANDLE



No.10



No.11



No.12



No.15



No.21



No.23

Bipolar Forceps



16 cm
19.5 cm
25 cm
BIPOLAR COAGULATION
FORCEPS BAYONET TIP-1MM



16 cm
19.5 cm
BIPOLAR COAGULATION
FORCEPS BAYONET TIP-1MM



16 cm
19.5 cm
BIPOLAR COAGULATION
FORCEPS BAYONET TIP-1MM
WITH SUCTION



16 cm
19.5 cm
BIPOLAR COAGULATION
FORCEPS (ST.)



16 cm
19.5 cm
BIPOLAR COAGULATION
FORCEPS (ST.)



16 cm
19.5 cm
BIPOLAR COAGULATION
FORCEPS CURVED TIP-1MM
WITH TWO PINS



16 cm
19.5 cm
BIPOLAR COAGULATION
FORCEPS CURVED TIP-1MM



16 cm
19.5 cm
BIPOLAR COAGULATION
FORCEPS CURVED TIP-1MM



16 cm
19.5 cm
BIPOLAR COAGULATION
FORCEPS CURVED TIP-1MM
WITH SUCTION



16 cm
19.5 cm
BIPOLAR COAGULATION
FORCEPS CURVED
WITH TWO PINS

Bipolar Forceps



19.5 cm
25cm
BIPOLAR COAGULATION
FORCEPS BAYONET TIP-1MM



19.5 cm
BIPOLAR COAGULATION
FORCEPS BAYONET TIP-1MM



19.5 cm
BIPOLAR COAGULATION
BAYONET TYPE TIP-1MM
WITH SUCTION



16 cm
19.5 cm
BIPOLAR COAGULATION
FORCEPS (ST.) TIP-1MM



16 cm
19.5 cm
BIPOLAR COAGULATION
FORCEPS (ST.) TIP-1MM



16 cm
19.5 cm
BIPOLAR COAGULATION
FORCEPS CURVED TIP-1MM



16 cm
19.5 cm
BIPOLAR COAGULATION
FORCEPS CURVED TIP-1MM
WITH TWO PINS



16 cm
19.5 cm
BIPOLAR COAGULATION
FORCEPS CURVED TIP-1MM



16 cm
19.5 cm
BIPOLAR COAGULATION
FORCEPS CURVED TIP-1MM
WITH SUCTION



16 cm 19.5 cm
BIPOLAR COAGULATION
FORCEPS CURVED
WITH TWO PINS TIP-1MM

Bipolar Forceps



BIPOLAR COAGULATION FORCEPS Tip-0.4mm



McPHERSON STRAIGHT FORCEPS 8cm Tip-0.4mm



McPHERSON CURVED FORCEPS 9cm Tip-0.4mm



JEWELER FORCEPS 11cm Tip-0.4mm



BIPOLAR FORCEPS 10cm Tip-0.4mm



ADSON FORCEPS
11cm, 14cm Tip-0.4mm

11cm
14cm



ARTERY FORCEPS
STRAIGHT
7"



ARTERY FORCEPS
CURVED
7"



TURNER WARWICK SCISSORS
STRAIGHT
7"



TURNER WARWICK SCISSORS
CURVED
7"

Bipolar Forceps



ADSON FORCEPS
Tip-0.4mm



McPHERSON STRAIGHT
FORCEPS 8cm Tip-0.4mm



McPHERSON CURVED
FORCEPS 9cm Tip-0.4mm



JEWELER
FORCEPS 11cm Tip-0.4mm



BIPOLAR FORCEPS
Tip-0.4mm 10cm



MONOPOLAR
SUCTION TUBE

SIZE
2.5
MM
3.5
MM
4.5
MM



SUCTION TUBE



NEEDLE



KNIFE

ABBEY SUB MUCOSAL RESECTION



MONOPOLAR CABLE



CABLE



BIPOLAR CABLE FLAT PIN



BIPOLAR CABLE TWO PIN

Trays & Drums



SURGICAL TRAY WITH LID
HEAVY STAINLESS STEEL
6" x 9"
7" x 11"
8" x 10"
10" x 12"
12" x 15"



DRESSING DRUMS
SEAMLESS STAINLESS STEEL
6" x 6"
9" x 9"
9" x 11"



MEASURING BOWL



MICRO INSTRUMENT POINTS



BOWL
STAINLESS STEEL
3"
4"
5"
6"
8"



KIDNEY TRAY
8"
10"

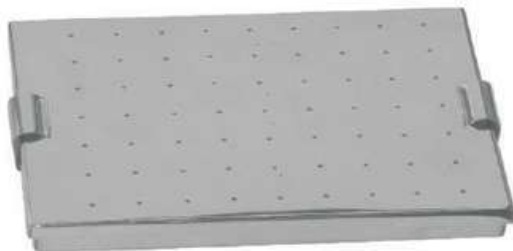

**INSTRUMENTS STERILIZING
PERFORATOR BOX**
STAINLESS STEEL

8" x 4" x 2"
11" x 7" x 2"





HEALTHCORE VENTURES

build.scale.expand.

Unit no 157, Kaliandas Udyog Bhavan, near Century Bazar, Prabhadevi, Mumbai- 400025

Tel: +91 86554 11521

Email: sales@healthcoreventures.com

Web: www.healthcoreventures.com